

Operating Manual



16 Series Mass and Volumetric Precision Gas Flow Meter

Notice: Alicat Scientific, Inc. reserves the right to make any changes and improvements to the products described in this manual at any time and without notice. This manual is copyrighted. This document may not, in whole or in part, be copied, reproduced, translated, or converted to any electronic medium or machine readable form, for commercial purposes, without prior written consent from the copyright holder.

Note: Although we provide assistance on Alicat Scientific products both personally and through our literature, it is the complete responsibility of the user to determine the suitability of any product to their application.

Alicat Scientific, Inc.'s Wide-Range Laminar Flow Element Patent: The wide-range laminar flow element and products using the wide-range laminar flow element are covered by U.S. Patent Number: 5,511,416. Manufacture or use of the wide-range laminar flow element in products other than Alicat Scientific products or other products licensed under said patent will be deemed an infringement.

Limited Lifetime Warranty

Alicat Scientific, Inc. warrants to the original purchaser (hereinafter referred to as "Buyer") that instruments manufactured by Alicat Scientific (hereinafter referred to as "Product") shall be free from defects in materials and workmanship for the life of the Products.

Under this warranty, the Product will be repaired or replaced at manufacturer's option, without charge for parts or labor when the Product is carried or shipped prepaid to the factory together with proof of purchase.

The foregoing shall constitute the exclusive and sole remedy in lieu of other remedies of the Buyer for any breach by Alicat Scientific of this warranty to the maximum extent permitted by law.

This warranty does not apply to any Product which has not been installed or used in accordance with the Product operation and installation specifications provided to Buyer verbally or in writing by Alicat Scientific for the proper and normal use of the Product.

Buyer agrees hereunder that Alicat reserves the right to void any warranty, written or implied, if upon Alicat's examination of Product shall disclose to Alicat's satisfaction that the Product failure was due solely, or in part, to accident, misuse, neglect, abuse, alteration, improper installation, unauthorized repair or improper testing by Buyer or agent of Buyer.

Alicat Scientific shall not be liable under any circumstances for indirect, special, consequential, or incidental damages in connection with, or arising out of, the sale, performance, or use of the Products covered by this warranty.

Alicat Scientific does not recommend, warrant or assume responsibility for the use of the Products in life support applications or systems.

Alicat's warranties as herein above set forth shall not be enlarged, diminished or affected by, and no obligation or liability shall arise or grow out of Alicat's rendering of technical advice in connection with Buyer's order of the Products furnished hereunder.

If Product becomes obsolete, Alicat Scientific, at its own discretion, reserves the right to repair the Product with available replacement parts or upgrade the Product to a current, commercially available version of the original Product. Should upgrading the Product be deemed necessary by Alicat, Buyer hereby agrees to pay an upgrade fee equal to seventy percent of the retail value of the replacement Product. Alicat Scientific hereunder makes no claim that replacement Products will look, function or operate in the same or similar manner as the original product.

When a Product is returned to Alicat Scientific for recalibration this service is considered normal preventative maintenance. Recalibration of Product shall not be treated as a warranty service unless recalibration of Product is required as the result of repairs to Product pursuant to this Warranty. **Failure to recalibrate Product on a yearly basis will remove any and all obligations regarding repair or replacement of Product as outlined by this Warranty to Buyer from Alicat Scientific.**

This Warranty is in lieu of all other relevant warranties, expressed or implied, including the implied warranty of merchantability and the implied warranty of fitness for a particular purpose, and any warranty against infringement of any patent.

Continued use or possession of Products after expiration of the applicable warranty period stated above shall be conclusive evidence that the warranty is fulfilled to the full satisfaction of Buyer.

Alicat makes no warranty as to experimental, non-standard or developmental Products.

Accessories purchased from Alicat are not covered by this warranty.

Conformity / Supplemental Information:

The product complies with the requirements of the Low Voltage Directive 73/23/EEC and the EMC Directive 89/336/EEC (including 93/68/EEC) and carries the CE Marking accordingly. Contact the manufacturer for more information.

Table of Contents	Page
Installation	5
Plumbing	5
Mounting	5
Application	5
Power and Signal Connections	6
RS-232 Digital Output Signal	7
Standard Voltage (0-5 Vdc) Output Signal	7
Optional 0-10 Vdc Output Signal	7
Optional Current (4-20 mA) Output Signal	7
Optional 2nd Analog Output Signal	7
M Series Mass Flow Meter Operation	10
Main Mode	10
Tare	10
Gas Absolute Pressure	11
Gas Temperature	11
Volumetric Flow Rate	11
Mass Flow Rate	11
<i>Flashing Error Message</i>	11
Select Menu Mode	12
Gas Select Mode	12
Communication Select Mode	13
Unit ID	13
Baud	13
Data Rate	13
Manufacturer Data Mode	14
Miscellaneous Mode	14
LCD Contrast	15
Display Zero Deadband	15
Pressure Averaging	15
Flow Averaging	15
V Series Volumetric Flow Meter Operation	16
Main Mode	16
Tare	16
<i>Flashing Error Message</i>	17
Select Menu Mode	17
Gas Select Mode	17
Communication Select Mode	17
Manufacturer Data Mode	17
Miscellaneous Mode	17
RS-232 Output and Input	17
Configuring HyperTerminal®	17
Changing from Streaming to Polling Mode	18

Table of Contents	Page
Tare	18
Gas Select	19
Collecting Data	20
Data Format	20
Sending a Simple Script File to HyperTerminal®	21
Operating Principle	22
Gas Viscosity	22
Other Gases	23
Volume Flow vs. Mass Flow	24
Volumetric Flow and Mass Flow Conversion	24
Compressibility	24
Standard Gas Data Tables	25
Gas Viscosities, Densities and Compressibilities at 25° C	26
Gas Viscosities, Densities and Compressibilities at 0° C	27
Volumetric Flow Meters Under Pressure	28
Troubleshooting	29
Maintenance and Recalibration	30
Technical Specifications	31
Dimensional Drawings	35
Additional Information	
Option: Totalizing Mode Screen	38
Option: Battery Pack	39
Option: Local SetPoint Module	41
Option: Remote Electronics	42
Accessory: BB-9 Multi-Drop Box	42
Accessory: RS-232 to RS-485 Converter	42
Accessory: Flow Vision	43
Accessories	44

Table of Figures	
Figure 1. 8 Pin Mini-DIN Connector	6
Figure 2. Mini-DIN to DB-9 Connection for RS-232 Signals	8
Figure 3. Typical Multiple Device (Addressable) Wiring Configuration	8
Figure 4. Optional Industrial Connector	9
Figure 5. Proper Set Up for Remote Tare on Meters	9
Figure 6. Main Mode Display, M Series Flow Meter	10
Figure 7. Select Menu Display	12
Figure 8. Gas Select Mode Display	12
Figure 9. Communication Select Display	13
Figure 10. Manufacturer Data Display	14
Figure 11. Miscellaneous Mode Display	15
Figure 12. Main Mode Display, V Series Flow Meter	16

Thank you for purchasing an M or V Series Gas Flow Meter. Please take the time to find and read the information contained in this manual. This will help to ensure that you get the best possible service from your instrument. This manual covers the following Alicat Scientific instruments:

M Series 16 Bit Mass Gas Flow Meters	M-XXSCCM-D
	M-XXSLPM-D
V Series 16 Bit Volumetric Gas Flow Meters	V-XXCCM-D
	V-XXLPM-D

Installation

Plumbing

All M and V Series Gas Flow Meters are equipped with female inlet and outlet port connections. Because the flow meters set up a laminar flow condition within the flow body, no straight runs of pipe are required upstream or downstream of the meter. The inlet and outlet ports are equal in size and symmetric (in-line). The port sizes (process connections) and mechanical dimensions for different flow ranges are shown on pages 31-34.

Meters with M5 (10-32) ports have o-ring face seals and require no further sealant or tape. On other meters, avoid the use of pipe dopes or sealants on the ports as these compounds can cause permanent damage to the meter should they get into the flow stream. Use of thread sealing Teflon tape is recommended to prevent leakage around the threads. When applying the tape, avoid wrapping the first thread or two to minimize the possibility of getting a piece of shredded tape into the flow stream. When changing fittings, always clean any tape or debris from the port threads.

It is also recommended that a 20 micron filter be installed upstream of meters with full scale ranges of 1(S)LPM or less and a 50 micron filter be installed upstream of meters with full scale ranges above 1(S)LPM.

Mounting

All M and V Series Gas Flow Meters have mounting holes for convenient mounting to flat panels. These meters are position insensitive and can be mounted in any orientation. The sizes and dimensions for the mounting holes are shown on pages 35-37.

Application

Maximum operating line pressure is 145 PSIG (1 MPa).

Caution: *Exceeding the maximum specified line pressure may cause permanent damage to the solid-state differential pressure transducer.*

If the line pressure is higher than 145 PSIG (1 MPa), a pressure regulator should be used upstream from the flow meter to reduce the pressure to 145 PSIG (1 MPa) or less if possible. Although the meter's operation is uni-directional, reversing the flow direction will inflict no damage as long as the maximum specified limits are not exceeded.

Note: *Avoid installations (such as snap acting solenoid valves upstream) that apply instantaneous high pressure to the meter as permanent damage to the differential pressure sensor could result. This damage is not covered under warranty!*

Power and Signal Connections

Power can be supplied to your M or V Series meter through either the power jack or the 8 pin Mini-DIN connector as shown in Figure 1. An AC to DC adapter which converts line AC power to DC voltage between 7 and 30 volts is required to use the power jack (Note: minimum 15Vdc required for 4-20mA outputs). The adapter current should be at least 100mA. The power jack accepts 2.1 mm female power plugs with positive centers. Cables and AC/DC adaptors maybe purchased from Alicat (see Accessories page 44) and are commonly available at local electronics suppliers. Alternatively, power can be supplied through the Mini-DIN connector as shown below:

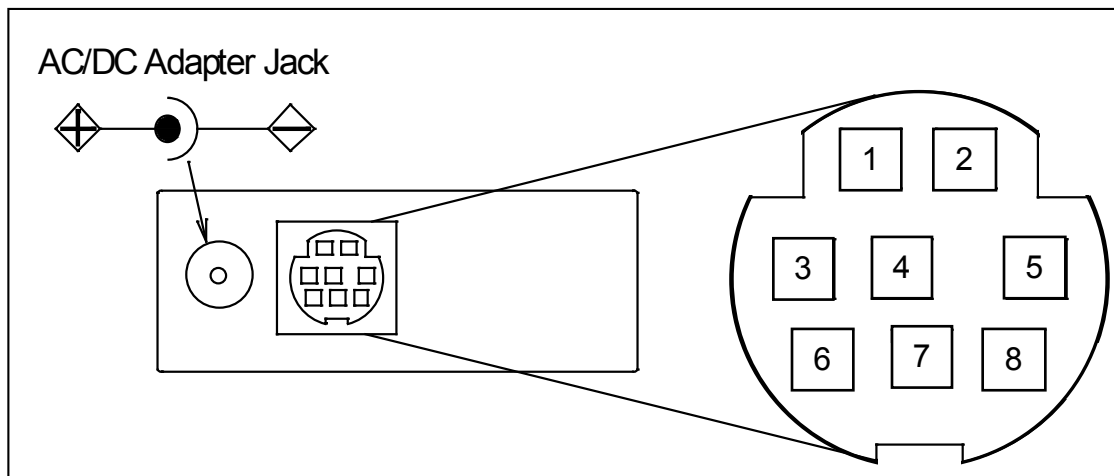

Pin	Function	Mini-DIN cable color
1	Inactive or <u>4-20mA Primary Output Signal</u>	Black
2	Static 5.12 Vdc or <u>Secondary Analog Output (4-20mA, 5Vdc, 10Vdc) or Basic Alarm</u>	Brown
3	RS-232 Input Signal	Red
4	Analog Input Signal = Remote Tare (Ground to Tare)	Orange
5	RS-232 Output Signal	Yellow
6	0-5 Vdc (or <u>0-10 Vdc</u>) Output Signal	Green
7	Power In (7-30 Vdc, 100mA) or (15-30Vdc for 4-20mA units)	Blue
8	Ground (common for power, communications and signals)	Purple

Note: The above pin-out is applicable to all the flow meters and controllers available with the Mini-DIN connector. The availability of different output signals depends on the flow meter options ordered. **Underlined Items** in the above table are optional configurations that are noted on the unit's calibration sheet.

Figure 1. 8 Pin Mini-DIN Connector

CAUTION: Do not connect power to pins 1 through 6 as permanent damage can occur!

Note: Upon initial review of the pin out diagram in Figure 1, it is common to mistake Pin 2 (labeled 5.12 Vdc Output) as the standard 0-5 Vdc analog output signal! In fact Pin 2 is normally a constant 5.12 Vdc that reflects the system bus voltage and can be used as a source for the set-point signal.

RS-232 Digital Output Signal

If you will be using the RS-232 output signal, it is necessary to connect the RS-232 Output Signal (Pin 5), the RS-232 Input Signal (Pin 3), and Ground (Pin 8) to your computer serial port as shown in Figure 2. Adapter cables are available from the manufacturer or they can be constructed in the field with parts from an electronics supply house. In Figure 2, note that the diagrams represent the “port” side of the connections, i.e. the connector on top of the meter and the physical DB-9 serial port on the back of the computer. The cable ends will be mirror images of the diagram shown in Figure 2. (See page 17 for details on accessing RS-232 output.)

Standard Voltage (0-5 Vdc) Output Signal

All M and V series flow meters have a 0-5 Vdc (optional 0-10 Vdc) output signal available on Pin 6. This is generally available in addition to other optionally ordered outputs. This voltage is usually in the range of 0.010 Vdc for zero flow and 5.0 Vdc for full-scale flow. The output voltage is linear over the entire range. Ground for this signal is common on Pin 8.

Optional 0-10 Vdc Output Signal

If your meter was ordered with a 0-10 Vdc output signal, it will be available on Pin 6. (See the Calibration Data Sheet that shipped with your meter to determine which output signals were ordered.) This voltage is usually in the range of 0.010 Vdc for zero flow and 10.0 Vdc for full-scale flow. The output voltage is linear over the entire range. Ground for this signal is common on Pin 8.

Optional Current (4-20 mA) Output Signal

If your meter was ordered with a 4-20 mA current output signal, it will be available on Pin 1. (See the Calibration Data Sheet that shipped with your meter to determine which output signals were ordered.) The current signal is 4 mA at 0 flow and 20 mA at the meter’s full scale flow. The output current is linear over the entire range. Ground for this signal is common on Pin 8. (Current output units require 15-30Vdc power.)

Note: *This is a current sourcing device. Do not attempt to connect it to “loop powered “ systems.*

Optional 2nd Analog Output Signal

You may specify an optional 2nd analog output on Pin 2 at time of order. (See the Calibration Data Sheet that shipped with your meter to determine which output signals were ordered.) This output may be a 0-5 Vdc, 0-10 Vdc, or 4-20 mA analog signal that can represent any measured parameter. With this optional output, a volumetric flow meter could output the volumetric flow rate with a 0-5 Vdc signal (on pin 6) and a 4-20 mA signal (on pin 2), or a mass flow meter could output the mass flow rate (0-5 Vdc on pin 6) and the absolute pressure (0-5 Vdc on pin 2).

Note: *This is a current sourcing device. Do not attempt to connect it to “loop powered “ systems.*

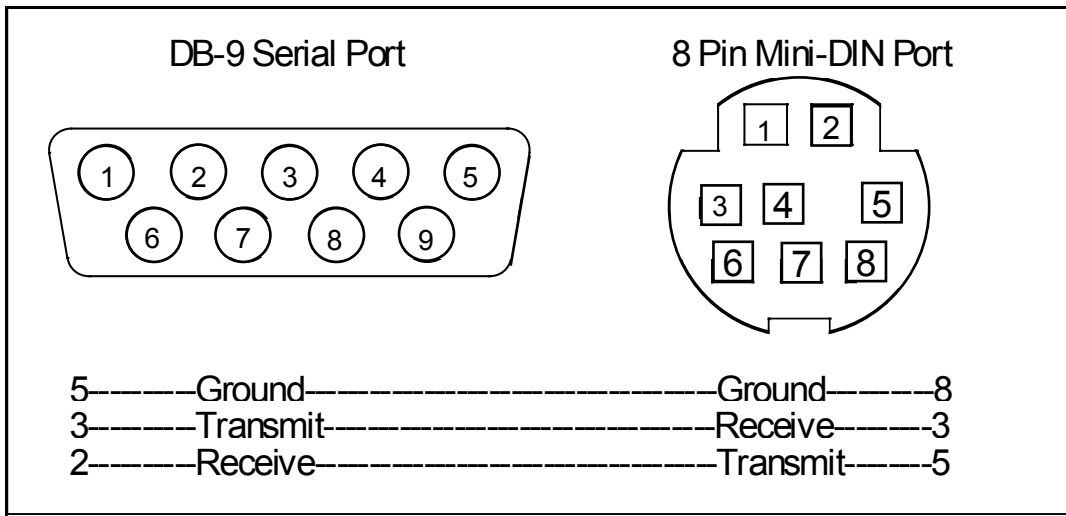

Figure 2. Mini-DIN to DB-9 Connection for RS-232 Signals

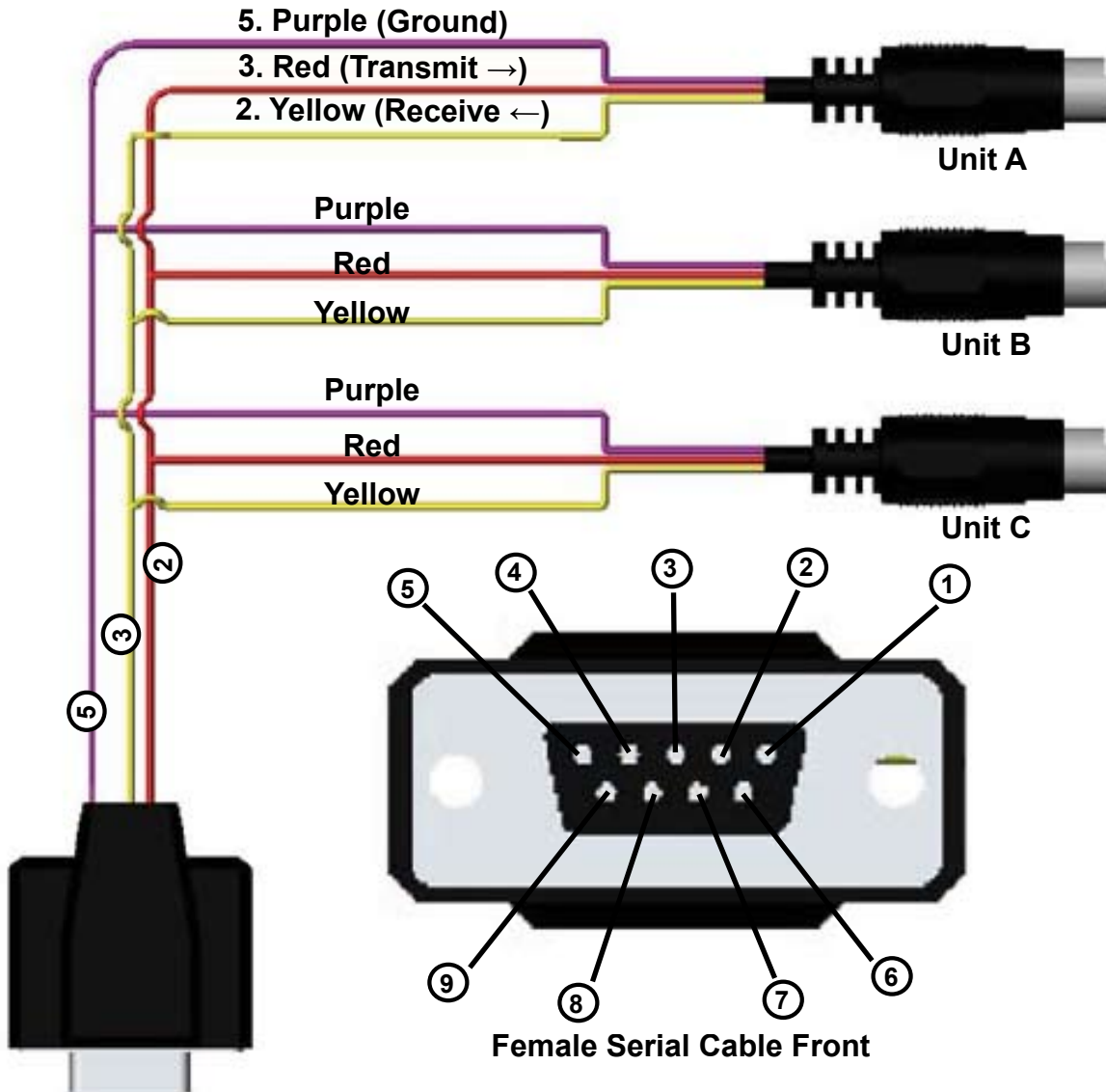

Figure 3. Typical Multiple Device (Addressable) Wiring Configuration

Note: The easiest way to connect multiple devices is with a Multi-Drop Box (see page 42).

An optional industrial connector is also available:

Pin	Function	Cable Color
1	Power In (+)	Red
2	RS-232 Output	Blue
3	RS-232 Input Signal	White
4	Remote Tare (Ground to Tare)	Green
5	Ground (common for power, communications and signals)	Black
6	Signal Out (Voltage or Current as ordered)	Brown

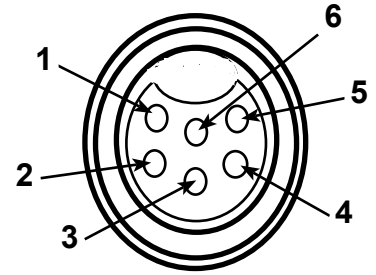

Figure 4. Optional Industrial Connector

Note: The above pin-out is applicable to all the flow meters and controllers ordered with the industrial connector. The availability of different output signals depends on the flow meter options ordered.

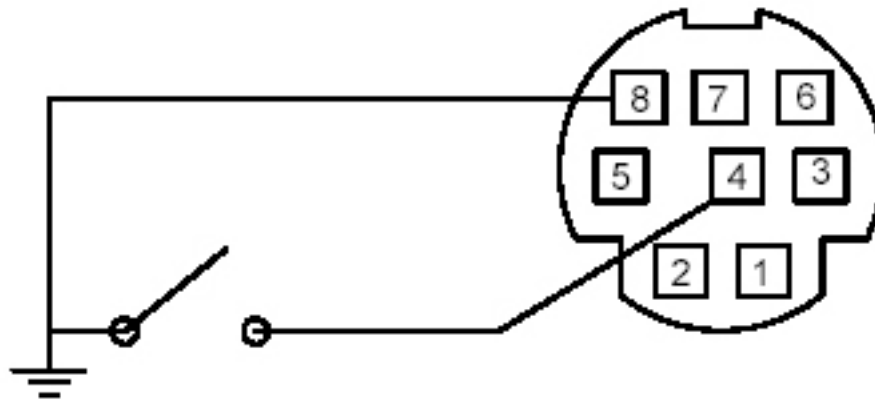

Figure 5. Proper set up for remote tare on meters (Momentarily ground Pin 4 to Tare)

M Series Mass Flow Meter Operation

The M Series Mass Flow Meter provides a multitude of useful flow data in one simple, rugged device. The M Series can have several screen “modes” depending on how the device is ordered. All M Series meters have a default Main Mode, Select Menu Mode, a Gas Select Mode (the Gas Select Mode may not be available on meters calibrated for a custom gas or blend), a Communication Select Mode, Manufacturer Data Mode and a Miscellaneous Mode. In addition, your device may have been ordered with the optional Totalizing Mode (page 38). The device defaults to Main Mode as soon as power is applied to the meter.

Main Mode

The main mode screen defaults on power up with the mass flow on the primary display. The following parameters are displayed in the main mode as shown in Figure 6:

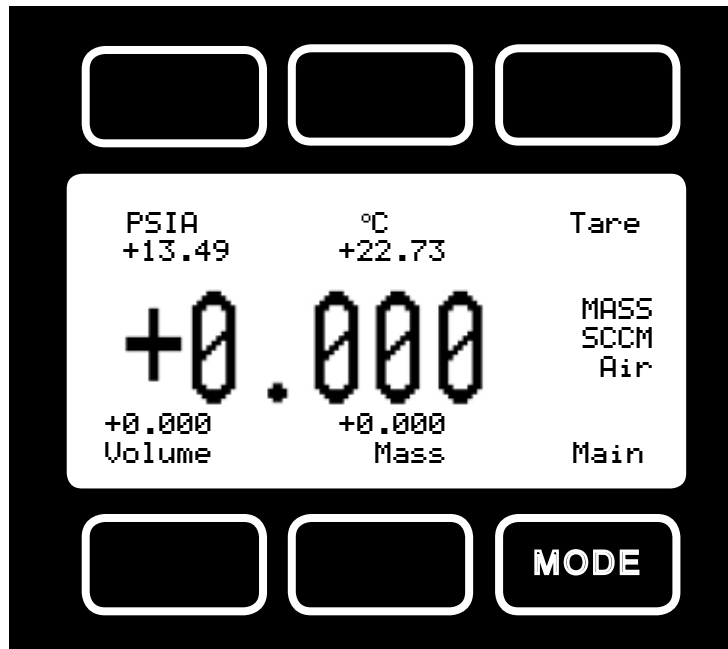

Figure 6. Main Mode Display, M Series Flow Meter

The “MODE” button in the lower right hand corner toggles the display between the Main display and the Select Menu display.

Tare – Pushing the dynamically labeled “Tare” button in the upper right hand corner tares the flow meter and provides it with a reference point for zero flow. This is a simple but important step in obtaining accurate measurements. It is good practice to “zero” the flow meter each time it is powered up. If the flow reading varies significantly from zero after an initial tare, give the unit a minute or so to warm up and re-zero it.

If possible, zero the unit near the expected operating pressure by positively blocking the flow downstream of the flow meter prior to pushing the “Tare” button. Zeroing the unit while there is any flow will directly affect the accuracy by providing a false zero point. If in doubt about whether a zero flow condition exists, remove the unit from the line and positively block both ports before pressing the “Tare” button. If the unit reads a significant negative value when removed from the line and blocked, it is a good indication that it was given a false zero. It is better to zero the unit at atmospheric pressure and a confirmed no flow conditions than to give it a false zero under line pressure.

Note: A remote tare can be achieved by momentarily grounding pin 4 to tare as shown in Figure 5 on page 9.

Gas Absolute Pressure: The M Series flow meters utilize an absolute pressure sensor to measure the line pressure of the gas flow being monitored. This sensor references hard vacuum and accurately reads line pressure both above and below local atmospheric pressure. This parameter is located in the upper left corner of the display under the dynamic label “PSIA”. This parameter can be moved to the primary display by pushing the button just above the dynamic label (top left). The engineering unit associated with absolute pressure is pounds per square inch absolute (PSIA). This can be converted to gage pressure (psig = the reading obtained by a pressure gauge that reads zero at atmospheric pressure) by simply subtracting local atmospheric pressure from the absolute pressure reading:

$$\text{PSIG} = \text{PSIA} - (\text{Local Atmospheric Pressure})$$

The flow meters use the absolute pressure of the gas in the calculation of the mass flow rate. For working in metric units, note that 1 PSI = 6.89 kPa.

Gas Temperature: The M Series flow meters also utilize a temperature sensor to measure the line temperature of the gas flow being monitored. The temperature is displayed in engineering units of degrees Celsius (°C). The flow meters use the temperature of the gas in the calculation of the mass flow rate. This parameter is located in the upper middle portion of the display under “°C”. This parameter can be moved to the primary display by pushing the top center button above “°C”.

Volumetric Flow Rate: The volumetric flow rate is determined using the Flow Measurement Operating Principle described elsewhere in this manual. This parameter is located in the lower left corner of the display over “Volume”. This parameter can be moved to the primary display by pushing the “Volume” button (lower left). In order to get an accurate volumetric flow rate, the gas being measured must be selected (see Gas Select Mode). This is important because the device calculates the flow rate based on the viscosity of the gas at the measured temperature. If the gas being measured is not what is selected, an incorrect value for the viscosity of the gas will be used in the calculation of flow, and the resulting output will be inaccurate in direct proportion to the ratio between the two gases viscosities.

Mass Flow Rate: The mass flow rate is the volumetric flow rate corrected to a standard temperature and pressure (typically 14.696 psia and 25°C). This parameter is located in the lower middle portion of the display over “Mass”. This parameter can be moved to the primary display by pushing the button located below “Mass” (bottom center). The meter uses the measured temperature and the measured absolute pressure to calculate what the flow rate would be if the gas pressure was at 1 atmosphere and the gas temperature was 25°C. This allows a solid reference point for comparing one flow to another.

Flashing Error Message: Our flow meters and controllers display an error message (MOV = mass overrange, VOV = volumetric overrange, POV = pressure overrange, TOV = temperature overrange) when a measured parameter exceeds the range of the sensors in the device. When any item flashes on the display, neither the flashing parameter nor the mass flow measurement is accurate. Reducing the value of the flashing parameter to within specified limits will return the unit to normal operation and accuracy.

Select Menu Mode

Pushing “Mode” once will bring up the “Select Menu” display. Push the button nearest your selection to go to the corresponding screen. Push “Mode” again to return to the Main Mode display. (**Note:** *If your meter was ordered with Totalizing Mode option (page 38), pushing the “Mode” button once will bring up the “Totalizing Mode” display. Pushing “Mode” a second time will bring up the “Select Menu” display.*)



Figure 7. Select Menu Display

Gas Select Mode

The gas select mode is accessed by pressing the button above “Gas” on the Select Menu display. The screen will appear as shown in Figure 8 below.

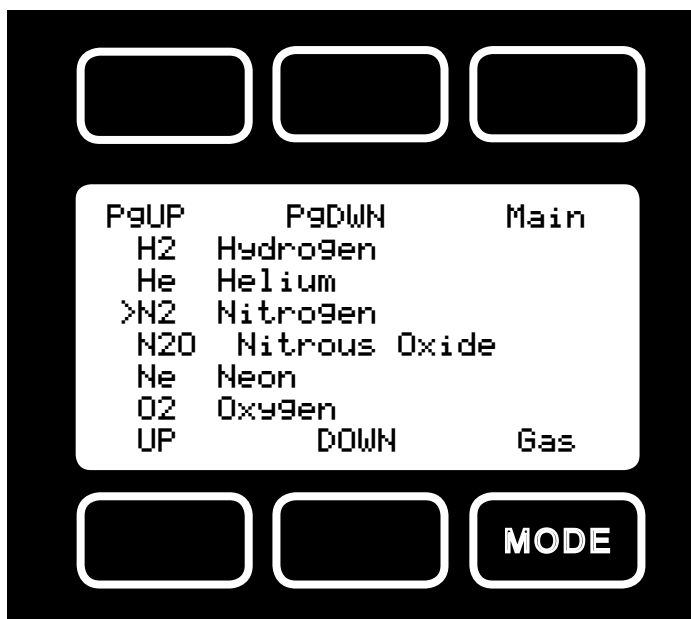

Figure 8. Gas Select Display

The selected gas is displayed on the default main mode screen as shown in Figure 6, and is indicated by the arrow in the Gas Select Mode screen in Figure 8. To change the selected gas, use the buttons under “UP” and “DOWN” or above “PgUP” and “PgDWN” to position the arrow in front of the desired gas. When the mode is cycled back to the Main Mode, the selected gas will be displayed on the main screen. (**Note:** *Gas Select Mode may not be available for units ordered for use with a custom gas or blend.*)

Communication Select

The Communication Select mode is accessed by pressing the button below “Comm. RS-232” on the Select Menu display. The screen will appear as shown in Figure 9 below.

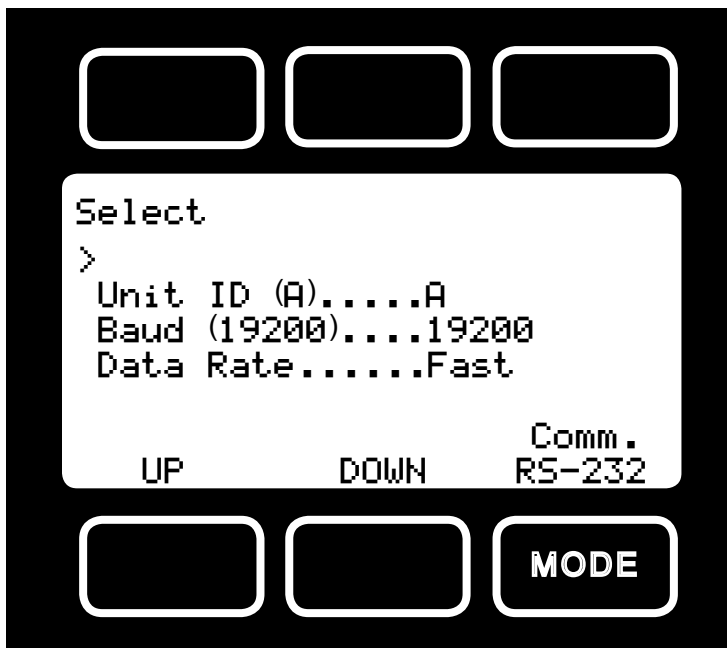

Figure 9. Communication Select Display

Unit ID – Valid unit identifiers are letters A-Z and @ (see **Note** below). This identifier allows the user to assign a unique address to each device so that multiple units can be connected to a single RS-232 port on a computer. The Communication Select Mode allows you to view and/or change a unit’s unique address. To change the unit ID address, press the “Select” button in the upper left corner of the display until the cursor arrow is in front of the word “Unit ID”. Then, using the UP and DOWN buttons at the bottom of the display, change the unit ID to the desired letter. **Any ID change will take effect when the Communication Select Screen is exited by pushing the MODE or Main button.**

Note: When the symbol @ is selected as the unit ID, the device will go into streaming mode when the Communication Select Mode is exited by pushing the MODE or Main button. See the RS-232 Communications chapter in this manual for information about the streaming mode.

Baud – The baud rate (bits per second) determines the rate at which data is passed back and forth between the instrument and the computer. Both devices must send/receive at the same baud rate in order for the devices to communicate via RS-232. The default baud rate for these devices is 19200 baud, sometimes referred to as 19.2K baud. To change the baud rate in the Communication Select Mode, press the “Select” button in the upper left corner of the display until the cursor arrow is in front of the word “Baud”. Then, using the UP and DOWN buttons at the bottom of the display, select the required baud rate to match your computer or PLC. The choices are 38400, 19200, 9600, or 2400 baud. **Any baud rate change will not take effect until power to the unit is cycled.**

Data Rate – Changing the Data Rate affects the rate at which the instrument dumps its data. Slow is ½ the Fast rate. The speed of the Fast rate is determined by the selected baud rate. It is sometimes desirable to reduce the data rate if the communication speed bogs down the computer’s processor (as is not uncommon in older laptops), or to reduce the size of data files collected in the streaming mode. To change the data rate in the Communication Select Mode, press the “Select” button in the upper left corner of the display until the cursor arrow is in front of the word “Data Rate”. Then, using the UP and DOWN buttons at the bottom of the display, select either Fast or Slow. **Any data rate change will be effective immediately upon changing the value between Fast and Slow.**

Manufacturer Data

“Manufacturer Data” is accessed by pressing the “Mfg. Data” button on the Select Menu display (Figure 7). The “Mfg 1” display shows the name and telephone number of the manufacturer. The “Mfg 2” display shows important information about your flow meter including the model number, serial number, and date of manufacture.

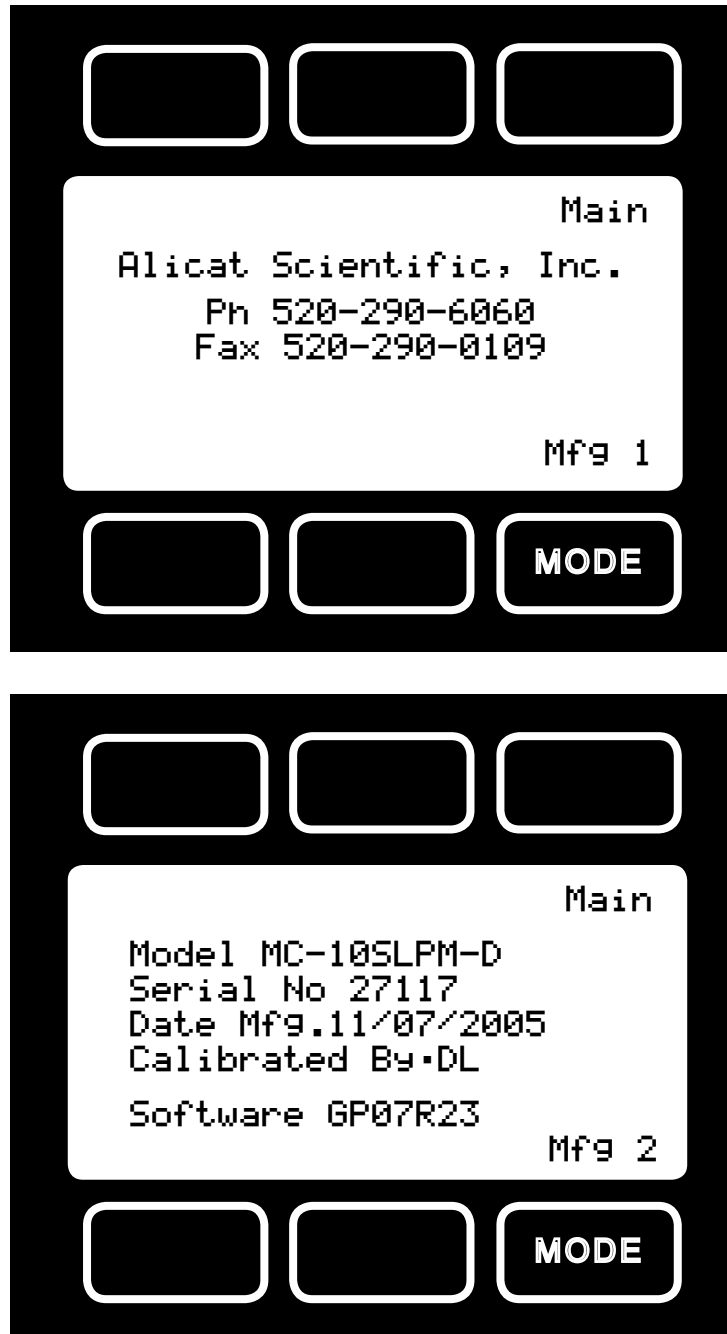

Figure 10. Manufacturer Data Displays

Miscellaneous Mode

The Miscellaneous mode is accessed by pressing the button above the “Misc” label in the upper right hand corner of the Select Menu display. The screen will appear as shown in Figure 11. Push the button above “Select” to move the cursor even with the item you wish to adjust. Then use the “UP” and “DOWN” buttons to make the adjustment.

NOTE: All Miscellaneous changes are recorded when you exit the Miscellaneous display.

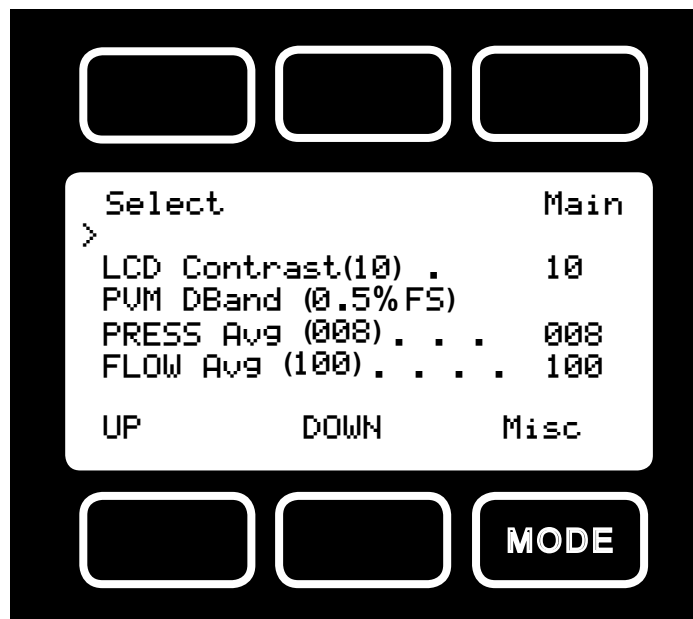

Figure 11. Miscellaneous Display

LCD Contrast: The Liquid Crystal Display Contrast can be adjusted between 0 and 30 with zero being the lightest contrast and 30 being the darkest contrast. To change the contrast, press the “Select” button in the upper left hand corner of the display until the cursor arrow is in front of the words “LCD Contrast (X)”. Then using the UP and DOWN buttons at the bottom of the display, change the contrast value as desired. The change is immediate and the effect can be monitored as the value is changed.

Display Zero Deadband: Zero deadband refers to a value below which the display simply jumps to zero. This deadband is often desired to prevent electrical noise from showing up on the display as minor flows or pressures that do not actually exist, especially in high noise (electrical) environments. This display deadband does not affect the analog or digital signal outputs — there is no zero deadband on the output signals. The display zero deadband can be adjusted between 0 and 3.2% of the Full Scale (FS) of the sensor. PVM refers to Pressure, Volumetric Flow and Mass Flow, the three parameters to which the deadband applies. To adjust the display zero deadband, press the “Select” button in the upper left hand corner of the display until the cursor arrow is in front of the words “PVM DBand (X %F.S.)”. Then using the UP and DOWN buttons at the bottom of the display, change the display zero deadband value as desired.

Pressure Averaging: It is sometimes advantageous to apply an averaging factor to the pressure output (and display) to make it easier to read and interpret rapidly fluctuating pressures. Pressure averaging can be adjusted between 1 (no averaging) and 256 (maximum averaging). This is a geometric running average where the number between 1 and 256 can be considered very roughly equivalent to the response time constant in milliseconds. This can be very effective at “smoothing” high frequency process oscillations such as those caused by diaphragm pumps. To adjust the pressure averaging, press the “Select” button in the upper left hand corner of the display until the cursor arrow is in front of the words “PRESS Avg (XXX)”. Then using the UP and DOWN buttons at the bottom of the display, change the pressure averaging value as desired.

Flow Averaging: It is sometimes advantageous to apply an averaging factor to the flow output (and display) to make it easier to read and interpret rapidly fluctuating flows. Flow averaging can be adjusted between 1 (no averaging) and 256 (maximum averaging). This is a geometric running average where the number between 1 and 256 can be considered very roughly equivalent to the response time constant in milliseconds. This can be very effective at “smoothing” high frequency process oscillations such as those caused by diaphragm pumps. To adjust the flow averaging, press the “Select” button in the upper left hand corner of the display until the cursor arrow is in front of the words “FLOW Avg (XXX)”. Then using the UP and DOWN buttons at the bottom of the display, change the flow averaging value as desired.

V Series Volumetric Flow Meter Operation

The V Series can have several screen “modes” depending on how the device is ordered. All V Series meters have a default Main Mode, Select Menu Mode, a Gas Select Mode (the Gas Select Mode may not be available on meters calibrated for a custom gas or blend), a Communication Select Mode, Manufacturer Data Mode and a Miscellaneous Mode. In addition, your device may have been ordered with the optional Totalizing Mode (page 38). The device defaults to Main Mode as soon as power is applied to the meter. **Note that volumetric meters are intended for use in near atmospheric conditions (Please see page 28).**

Main Mode

The main mode screen shows the volumetric flow in the units specified at time of order. In the flow mode, only two buttons are active as shown in Figure 12. The process gas that is selected is shown directly under the flow units.

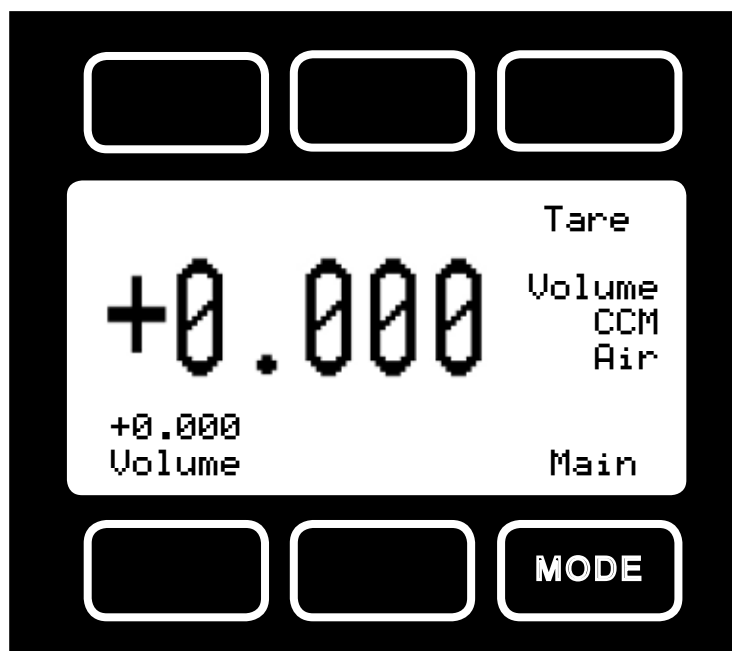

Figure 12. Main Mode Display, V Series Flow Meter

The “MODE” button in the lower right hand corner toggles the display between the Main Display and the Menu Display.

Tare – Pushing the dynamically labeled “Tare” button in the upper right hand corner tares the flow meter and provides it with a reference point for zero flow. This is a simple but important step in obtaining accurate measurements. It is good practice to “zero” the flow meter each time it is powered up and whenever a known zero flow condition exists. If the flow reading varies significantly from zero after an initial tare, give the unit a minute or so to warm up and re-zero it.

Zeroing the unit while there is any flow will directly affect the accuracy by providing a false zero point. If in doubt about whether a zero flow condition exists, remove the unit from the line and positively block both ports before pressing the “Tare” button. If the unit reads a significant negative value when removed from the line and blocked, it is a good indication that it was given a false zero. It is better to zero the unit at atmospheric pressure and a confirmed “no flow” condition than to give it a false zero under line pressure.

Note: A remote tare can be achieved by momentarily grounding pin 4 to tare as shown in Figure 5 on page 9.

Flashing Error Message: Our volumetric flow meters and controllers display an error message (VOV = volumetric overrange) when a measured parameter exceeds the range of the sensors in the device. When any item flashes on the display, the flashing parameter is not accurate. Reducing the value of the flashing parameter to within specified limits will return the unit to normal operation and accuracy.

Select Menu Mode

Pushing “Mode” once will bring up the “Select Menu” display (Figure 7, page 12). Push the button nearest your selection to go to the corresponding screen. Push “Mode” again to return to the Main Mode display. (**Note:** *If your meter was ordered with Totalizing Mode option (page 38), pushing the “Mode” button once will bring up the “Totalizing Mode” display. Pushing “Mode” a second time will bring up the “Select Menu” display.*)

Gas Select Mode

The Gas Select Mode is accessed by pressing the button above “Gas Select” on the Select Menu display. The screen will appear as shown in Figure 8 (page 12). The selected gas is displayed on the default main mode screen as shown in Figure 11, and is indicated by the arrow in the gas select mode screen in Figure 8. To change the selected gas, use the buttons under “UP” and “DOWN” or those above “PgUP” and “PgDWN” to position the arrow in front of the desired gas. When the mode is cycled back to the main mode, the selected gas will be displayed on the main screen.

Note: *Gas Select Mode may not be available for units ordered for use with a custom gas or blend.*

Communication Select Mode

The Communication Select mode is accessed by pressing the button below “Comm. RS-232” on the Select Menu display. Please see page 13 for Communication Select mode instructions.

Manufacturer Data Mode

“Manufacturer Data” is accessed by pressing the “Mfg. Data” button on the Select Menu display (Figure 7, page 12). The “Mfg 1” display shows the name and telephone number of the manufacturer. The “Mfg 2” display shows important information about your flow meter including the model number, serial number, and date of manufacture (Figure 10, page 14).

Miscellaneous Mode

The Miscellaneous mode is accessed by pressing the button above the “Misc” label in the upper right hand corner of the Select Menu display. The screen will appear as shown in Figure 11. Push the button above “Select” to move the cursor even with the item you wish to adjust. Then use the “UP” and “DOWN” buttons to make the adjustment. See pages 14 & 15.

NOTE: *All Miscellaneous changes are recorded when you exit the Miscellaneous display.*

RS-232 Output and Input

Configuring HyperTerminal®:

1. Open your HyperTerminal® RS-232 terminal program (installed under the “Accessories” menu on all Microsoft Windows® operating systems).
2. Select “Properties” from the file menu.
3. Click on the “Configure” button under the “Connect To” tab. Be sure the program is set for: 19,200 baud (or matches the baud rate selected in the RS-232 communications menu on the meter) and an 8-N-1-None (8 Data Bits, No Parity, 1 Stop Bit, and no Flow Control) protocol.
4. Under the “Settings” tab, make sure the Terminal Emulation is set to ANSI or Auto Detect.
5. Click on the “ASCII Setup” button and be sure the “Send Line Ends with Line Feeds” box is not checked and the “Echo Typed Characters Locally” box and the “Append Line Feeds to Incoming Lines” boxes are checked. Those settings not mentioned here are normally okay in the default position.
6. Save the settings, close HyperTerminal® and reopen it.

In Polling Mode, the screen should be blank except the blinking cursor. In order to get the data streaming to the screen, hit the “Enter” key several times to clear any extraneous information. Type “*@=@” followed by “Enter” (or using the RS-232 communication select menu, select @ as identifier and exit the screen). If data still does not appear, check all the connections and com port assignments.

Changing From Streaming to Polling Mode:

When the meter is in the Streaming Mode, the screen is updated approximately 10-60 times per second (depending on the amount of data on each line) so that the user sees the data essentially in real time. It is sometimes desirable, and necessary when using more than one unit on a single RS-232 line, to be able to poll the unit.

In Polling Mode the unit measures the flow normally, but only sends a line of data when it is “polled”. Each unit can be given its own unique identifier or address. Unless otherwise specified each unit is shipped with a default address of capital A. Other valid addresses are B thru Z.

Once you have established communication with the unit and have a stream of information filling your screen:

1. Type *@=A followed by “Enter” (or using the RS-232 communication select menu, select A as identifier and exit the screen) to stop the streaming mode of information. Note that the flow of information will not stop while you are typing and you will not be able to read what you have typed. Also, the unit does not accept a backspace or delete in the line so it must be typed correctly. If in doubt, simply hit enter and start again. If the unit does not get exactly what it is expecting, it will ignore it. If the line has been typed correctly, the data will stop.
2. You may now poll the unit by typing A followed by “Enter”. This does an instantaneous poll of unit A and returns the values once. You may type A “Enter” as many times as you like. Alternately you could resume streaming mode by typing *@=@ followed by “Enter”. Repeat step 1 to remove the unit from the streaming mode.
3. To assign the unit a new address, type *@=New Address, e.g. *@=B. Care should be taken not to assign an address to a unit if more than one unit is on the RS232 line as all of the addresses will be reassigned. Instead, each should be individually attached to the RS-232 line, given an address, and taken off. After each unit has been given a unique address, they can all be put back on the same line and polled individually.

Tare –Tareing (or zeroing) the flow meter provides it with a reference point for zero flow. This is a simple but important step in obtaining accurate measurements. It is good practice to “zero” the flow meter each time it is powered up. A unit may be Tared by following the instructions on page 10 or it may be Tared via RS-232 input.

To send a Tare command via RS-232, enter the following strings:

In Streaming Mode: \$\$V<Enter>

In Polling Mode: Address\$\$V<Enter> (e.g. B\$\$V<Enter>)

Gas Select – The selected gas can be changed via RS-232 input. To change the selected gas, enter the following commands:

In Streaming Mode: \$\$#<Enter>

In Polling Mode: Address\$\$#<Enter> (e.g. B\$\$#<Enter>)

Where # is the number of the gas selected from the table below. Note that this also corresponds to the gas select menu on the flow meter screen:

#	GAS	
0	Air	Air
1	Argon	Ar
2	Methane	CH4
3	Carbon Monoxide	CO
4	Carbon Dioxide	CO2
5	Ethane	C2H6
6	Hydrogen	H2
7	Helium	He
8	Nitrogen	N2
9	Nitrous Oxide	N2O
10	Neon	Ne
11	Oxygen	O2
12	Propane	C3H8
13	normal-Butane	n-C4H10
14	Acetylene	C2H2
15	Ethylene	C2H4
16	iso-Butane	i-C4H10
17	Krypton	Kr
18	Xenon	Xe
19	Sulfur Hexafluoride	SF6
20	75% Argon / 25% CO2	C-25
21	90% Argon / 10% CO2	C-10
22	92% Argon / 8% CO2	C-8
23	98% Argon / 2% CO2	C-2
24	75% CO2 / 25% Argon	C-75
25	75% Argon / 25% Helium	A-75
26	75% Helium / 25% Argon	A-25
27	90% Helium / 7.5% Argon / 2.5% CO2 (Praxair - Helistar® A1025)	A1025
28	90% Argon / 8% CO2 / 2% Oxygen (Praxair - Stargon® CS)	Star29
29	95% Argon / 5% Methane	P-5

For example, to select Propane, enter: \$\$12<Enter>

Collecting Data:

The RS-232 output updates to the screen many times per second. Very short-term events can be captured simply by disconnecting (there are two telephone symbol icons at the top of the HyperTerminal® screen for disconnecting and connecting) immediately after the event in question. The scroll bar can be driven up to the event and all of the data associated with the event can be selected, copied, and pasted into Microsoft® Excel® or other spreadsheet program as described below.

For longer term data, it is useful to capture the data in a text file. With the desired data streaming to the screen, select “Capture Text” from the Transfer Menu. Type in the path and file name you wish to use. Push the start button. When the data collection period is complete, simply select “Capture Text” from the Transfer Menu and select “Stop” from the sub-menu that appears.

Data that is selected and copied, either directly from HyperTerminal® or from a text file can be pasted directly into Excel®. When the data is pasted it will all be in the selected column. Select “Text to Columns...” under the Data menu in Excel® and a Text to Columns Wizard (dialog box) will appear. Make sure that “Fixed Width” is selected under Original Data Type in the first dialog box and click “Next”. In the second dialog box, set the column widths as desired, but the default is usually acceptable. Click on “Next” again. In the third dialog box, make sure the column data format is set to “General”, and click “Finish”. This separates the data into columns for manipulation and removes symbols such as the plus signs from the numbers. Once the data is in this format, it can be graphed or manipulated as desired.

For extended term data capture see: “Sending a Simple Script to HyperTerminal®” on page 21.

Data Format:

The data stream on the screen represents the flow parameters of the main mode in the units shown on the display. For volumetric flow meters, there are two columns of data representing volumetric flow rate in the units specified at time of order and the selected gas.

```
+4.123 Air  
+4.123 Air  
+4.123 Air  
+4.123 Air  
+4.124 Air  
+4.125 Air
```

V Series Volumetric Flow Meter Data Format

For mass flow meters, there are 5 columns of data representing pressure, temperature, volumetric flow, mass flow and the selected gas. The first column is absolute pressure (normally in PSIA), the second column is temperature (normally in °C), the third column is volumetric flow rate (in the units specified at time of order and shown on the display), and the fourth column is mass flow (also in the units specified at time of order and shown on the display). For instance, if the meter was ordered in units of SCFM, the display on the meter would read 2.004 SCFM and the last two columns of the output below would represent volumetric flow and mass flow in CFM and SCFM respectively.

```
+014.70 +025.00 +02.004 +02.004 Air  
+014.70 +025.00 +02.004 +02.004 Air  
+014.70 +025.00 +02.004 +02.004 Air  
+014.70 +025.00 +02.004 +02.004 Air  
+014.70 +025.00 +02.004 +02.004 Air  
+014.70 +025.00 +02.004 +02.004 Air
```

M Series Mass Flow Meter Data Format

Sending a Simple Script File to HyperTerminal®

It is sometimes desirable to capture data for an extended period of time. Standard streaming mode information is useful for short term events, however, when capturing data for an extended period of time, the amount of data and thus the file size can become too large very quickly. Without any special programming skills, the user can use HyperTerminal and a text editing program such as Microsoft Word to capture text at user defined intervals.

1. Open your text editing program, MS Word for example.
2. Set the cap lock on so that you are typing in capital letters.
3. Beginning at the top of the page, type A<Enter> repeatedly. If you're using MS Word, you can tell how many lines you have by the line count at the bottom of the screen. The number of lines will correspond to the total number of times the flow device will be polled, and thus the total number of lines of data it will produce.

For example: A

A

A

A

A

A

will get a total of six lines of data from the flow meter, but you can enter as many as you like.

The time between each line will be set in HyperTerminal.

4. When you have as many lines as you wish, go to the File menu and select save. In the save dialog box, enter a path and file name as desired and in the "Save as Type" box, select the plain text (.txt) option. It is important that it be saved as a generic text file for HyperTerminal to work with it.
5. Click Save.
6. A file conversion box will appear. In the "End Lines With" drop down box, select CR Only. Everything else can be left as default.
7. Click O.K.
8. You have now created a "script" file to send to HyperTerminal. Close the file and exit the text editing program.
9. Open HyperTerminal and establish communication with your flow device as outlined in the manual.
10. Set the flow device to Polling Mode as described in the manual. Each time you type A<Enter>, the meter should return one line of data to the screen.
11. Go to the File menu in HyperTerminal and select "Properties".
12. Select the "Settings" tab.
13. Click on the "ASCII Setup" button.
14. The "Line Delay" box is defaulted to 0 milliseconds. This is where you will tell the program how often to read a line from the script file you've created. 1000 milliseconds is one second, so if you want a line of data every 30 seconds, you would enter 30000 into the box. If you want a line every 5 minutes, you would enter 300000 into the box.
15. When you have entered the value you want, click on OK and OK in the Properties dialog box.
16. Go the Transfer menu and select "Send **Text** File..." (NOT Send File...).
17. Browse and select the text "script" file you created.
18. Click Open.
19. The program will begin "executing" your script file, reading one line at a time with the line delay you specified and the flow device will respond by sending one line of data for each poll it receives, when it receives it.

You can also capture the data to another file as described in the manual under "Collecting Data". You will be simultaneously sending it a script file and capturing the output to a separate file for analysis.

Operating Principle

All M and V Series Gas Flow Meters are based on the accurate measurement of volumetric flow. The volumetric flow rate is determined by creating a pressure drop across a unique internal restriction, known as a Laminar Flow Element (LFE), and measuring differential pressure across it. The restriction is designed so that the gas molecules are forced to move in parallel paths along the entire length of the passage; hence laminar (streamline) flow is established for the entire range of operation of the device. Unlike other flow measuring devices, in laminar flow meters the relationship between pressure drop and flow is linear. The underlying principle of operation of the 16 Series flow meters is known as the Poiseuille Equation:

$$Q = (P_1 - P_2) \pi r^4 / 8 \eta L \quad (\text{Equation 1})$$

Where:

Q	=	Volumetric Flow Rate
P ₁	=	Static pressure at the inlet
P ₂	=	Static pressure at the outlet
r	=	Radius of the restriction
η	=	(eta) absolute viscosity of the fluid
L	=	Length of the restriction

Since π, r and L are constant; Equation 1 can be rewritten as:

$$Q = K (\Delta P / \eta) \quad (\text{Equation 2})$$

Where K is a constant factor determined by the geometry of the restriction. Equation 2 shows the linear relationship between volumetric flow rate (Q) differential pressure (ΔP) and absolute viscosity (η) in a simpler form.

Gas Viscosity: In order to get an accurate volumetric flow rate, the gas being measured must be selected (see Gas Select Mode, page 12). This is important because the device calculates the flow rate based on the viscosity of the gas at the measured temperature. If the gas being measured is not what is selected, an incorrect value for the viscosity of the gas will be used in the calculation of flow, and the resulting output will be inaccurate in direct proportion to the difference in the two gases viscosities.

Gas viscosity, and thus gas composition, can be very important to the accuracy of the meter. Anything that has an effect on the gas viscosity (e.g. water vapor, odorant additives, etc.) will have a direct proportional effect on the accuracy. Selecting methane and measuring natural gas for instance, will result in a fairly decent reading, but it is not highly accurate (errors are typically < 0.6%) because natural gas contains small and varying amounts of other gases such as butane and propane that result in a viscosity that is somewhat different than pure methane.

Absolute viscosity changes very little with pressure (within the operating ranges of these meters) therefore a true volumetric reading does not require a correction for pressure. Changes in gas temperature do affect viscosity. For this reason, the M and V Series internally compensate for this change.

Other Gases: M Series Flow Meters can easily be used to measure the flow rate of gases other than those listed as long as “non-corrosive” gas compatibility is observed. For example, a flow meter that has been set for air can be used to measure the flow of argon.

The conversion factor needed for measuring the flow of different gases is linear and is simply determined by the ratio of the absolute viscosity of the gases. This factor can be calculated as follows:

$$Q_{og} = Q_1 [\eta_1 / \eta_{og}]$$

Where:

Q_1	=	Flow rate indicated by the flow meter
η_1	=	Viscosity of the calibrated gas at the measured temp.
Q_{og}	=	Flow rate of the alternate gas
η_{og}	=	Viscosity of the alternate gas at the measured temp.

Say we have a meter set for air and we want to flow argon through it. With argon flowing through the meter, the display reads 110 SLPM. For ease of calculation, let us say the gas temperature is 25°C. What is the actual flow of argon?

Q_{og}	=	Actual Argon Flow Rate
Q_1	=	Flow rate indicated by meter (110 SLPM)
η_1	=	Viscosity of gas selected or calibrated for by the meter at the measured temp.
η_{og}	=	Viscosity of gas flowing through the meter at the measured temp.

At 25°C, the absolute viscosity of Air (η_1) is 184.918 micropoise.

At 25°C, the absolute viscosity of Argon (η_{og}) is 225.593 micropoise.

Q_{og}	=	$Q_1 (\eta_1 / \eta_{og})$
Q_{og}	=	110 SLPM (184.918 / 225.593)
Q_{og}	=	90.17 SLPM

So, the actual flow of Argon through the meter is 90.17 SLPM. As you can see, because the Argon gas is more viscous than the Air the meter is set for, the meter indicates a higher flow than the actual flow.

A good rule of thumb is: “At a given flow rate, the higher the viscosity, the higher the indicated flow.”

Volume Flow vs. Mass Flow: At room temperature and low pressures the volumetric and mass flow rate will be nearly identical, however, these rates can vary drastically with changes in temperature and/or pressure because the temperature and pressure of the gas directly affects the volume. For example, assume a volumetric flow reading was used to fill balloons with 250 mL of helium, but the incoming line ran near a furnace that cycled on and off, intermittently heating the incoming helium. Because the volumetric meter simply measures the volume of gas flow, all of the balloons would initially be the same size. However, if all the balloons are placed in a room and allowed to come to an equilibrium temperature, they would generally all come out to be different sizes. If, on the other hand, a mass flow reading were used to fill the balloons with 250 standard mL of helium, the resulting balloons would initially be different sizes, but when allowed to come to an equilibrium temperature, they would all turn out to be the same size.

This parameter is called corrected mass flow because the resulting reading has been compensated for temperature and pressure and can therefore be tied to the mass of the gas. Without knowing the temperature and pressure of the gas and thus the density, the mass of the gas cannot be determined.

This reduces to: $P_a V_a / Z_a T_a = P_s V_s / Z_s T_s$, eliminating R and n.

Alicat mass flow meters model gas flows based upon the non-ideal gas characteristics of the calibrated gas. The flow corrections are normally made to 25 C and 14.696 PSIA and the compressibility factor of the gas under those conditions. This allows the user to multiply the mass flow rate by the density of the real gas at those standard conditions to get the mass flow rate in grams per minute.

Because we incorporate the compressibility factor into our 'full gas model'; attempts to manually compute mass flows from only the P, V, and T values shown on the display will sometimes result in modest errors.

Note: Although the correct units for mass are expressed in grams, kilograms, etc. it has become standard that mass flow rate is specified in SLPM (standard liters / minute), SCCM (standard cubic centimeters / minute) or SmL/M (standard milliliters / minute).

This means that mass flow rate is calculated by normalizing the volumetric flow rate to some standard temperature and pressure (STP). By knowing the density at that STP, one can determine the mass flow rate in grams per minute, kilograms per hour, etc.

STP is usually specified as the sea level conditions; however, no single standard exists for this convention. Examples of common reference conditions include:

0°C	and	14.696 PSIA
25°C	and	14.696 PSIA
0°C	and	760 torr (mmHG)
70°F	and	14.696 PSIA
68°F	and	29.92 inHG
20°C	and	760 torr (mmHG)

M Series Flow Meters reference 25°C and 14.696 PSIA (101.32kPa) - unless ordered otherwise. Refer to the calibration sheet to confirm the reference point.

Standard Gas Data Tables: Those of you who have older Alicat products (manufactured before October 2005) may notice small discrepancies between the gas property tables of your old and new units. Alicat Scientific, Inc. has recently incorporated the latest data sets from NIST (including their REFPROP 7 data) in our products' built-in gas property models. Be aware that calibrators that you may be spot checking against may be using older data sets such as the widely distributed Air Liquide data. This may generate apparent calibration discrepancies of up to 0.6% of reading on well behaved gases and as much as 3% of reading on some gases such as propane and butane, unless the standard was directly calibrated on the gas in question. As the older standards are phased out of the industry, this difference in readings will cease to be a problem. If you see a difference between the Alicat meter and your in-house standard, in addition to calling Alicat Scientific at (520) 290-6060, call the manufacturer of your standard for clarification as to which data set they used in their calibration. This comparison will in all likelihood resolve the problem.

Gas Number	Short Form	Long Form	Viscosity* 25 deg C 14.696 PSIA	Density** 25 deg C 14.696 PSIA	Compressibility 25 deg C 14.696 PSIA
0	Air	Air	184.918	1.1840	0.9997
1	Ar	Argon	225.593	1.6339	0.9994
2	CH4	Methane	111.852	0.6569	0.9982
3	CO	Carbon Monoxide	176.473	1.1453	0.9997
4	CO2	Carbon Dioxide	149.332	1.8080	0.9949
5	C2H6	Ethane	93.540	1.2385	0.9924
6	H2	Hydrogen	89.153	0.08235	1.0006
7	He	Helium	198.457	0.16353	1.0005
8	N2	Nitrogen	178.120	1.1453	0.9998
9	N2O	Nitrous Oxide	148.456	1.8088	0.9946
10	Ne	Neon	311.149	0.8246	1.0005
11	O2	Oxygen	204.591	1.3088	0.9994
12	C3H8	Propane	81.458	1.8316	0.9841
13	n-C4H10	normal-Butane	74.052	2.4494	0.9699
14	C2H2	Acetylene	104.448	1.0720	0.9928
15	C2H4	Ethylene	103.177	1.1533	0.9943
16	i-C4H10	iso-Butane	74.988	2.4403	0.9728
17	Kr	Krypton	251.342	3.4274	0.9994
18	Xe	Xenon	229.785	5.3954	0.9947
19	SF6	Sulfur Hexafluoride	153.532	6.0380	0.9887
20	C-25	75% Argon / 25% CO2	205.615	1.6766	0.9987
21	C-10	90% Argon / 10% CO2	217.529	1.6509	0.9991
22	C-8	92% Argon / 8% CO2	219.134	1.6475	0.9992
23	C-2	98% Argon / 2% CO2	223.973	1.6373	0.9993
24	C-75	75% CO2 / 25% Argon	167.451	1.7634	0.9966
25	A-75	75% Argon / 25% Helium	230.998	1.2660	0.9997
26	A-25	75% Helium / 25% Argon	234.306	0.5306	1.0002
27	A1025	90% Helium / 7.5% Argon / 2.5% CO2 (Praxair - Helistar® A1025)	214.840	0.3146	1.0003
28	Star29	90% Argon / 8% CO2 / 2% Oxygen (Praxair - Stargon® CS)	218.817	1.6410	0.9992
29	P-5	95% Argon / 5% Methane	223.483	1.5850	0.9993
*in micropoise (1 Poise = gram / (cm) (sec))			** Grams/Liter	(NIST REFPROP 7 database)	

Gas Viscosities, Densities and Compressibilities at 25° C

Gas Number	Short Form	Long Form	Viscosity* 0 deg C 14.696 PSIA	Density** 0 deg C 14.696 PSIA	Compressibility 0 deg C 14.696 PSIA
0	Air	Air	172.588	1.2927	0.9994
1	Ar	Argon	209.566	1.7840	0.9991
2	CH4	Methane	103.657	0.7175	0.9976
3	CO	Carbon Monoxide	165.130	1.2505	0.9994
4	CO2	Carbon Dioxide	137.129	1.9768	0.9933
5	C2H6	Ethane	86.127	1.3551	0.9900
6	H2	Hydrogen	83.970	0.08988	1.0007
7	He	Helium	186.945	0.17849	1.0005
8	N2	Nitrogen	166.371	1.2504	0.9995
9	N2O	Nitrous Oxide	136.350	1.9778	0.9928
10	Ne	Neon	293.825	0.8999	1.0005
11	O2	Oxygen	190.555	1.4290	0.9990
12	C3H8	Propane	74.687	2.0101	0.9787
13	n-C4H10	normal-Butane	67.691	2.7048	0.9587
14	C2H2	Acetylene	97.374	1.1728	0.9905
15	C2H4	Ethylene	94.690	1.2611	0.9925
16	i-C4H10	iso-Butane	68.759	2.6893	0.9627
17	Kr	Krypton	232.175	3.7422	0.9991
18	Xe	Xenon	212.085	5.8988	0.9931
19	SF6	Sulfur Hexafluoride	140.890	6.6154	0.9850
20	C-25	75% Argon / 25% CO2	190.579	1.8309	0.9982
21	C-10	90% Argon / 10% CO2	201.897	1.8027	0.9987
22	C-8	92% Argon / 8% CO2	203.423	1.7989	0.9988
23	C-2	98% Argon / 2% CO2	208.022	1.7877	0.9990
24	C-75	75% CO2 / 25% Argon	154.328	1.9270	0.9954
25	A-75	75% Argon / 25% Helium	214.808	1.3821	0.9995
26	A-25	75% Helium / 25% Argon	218.962	0.5794	1.0002
27	A1025	90% Helium / 7.5% Argon / 2.5% CO2 (Praxair - Helistar® A1025)	201.284	0.3434	1.0002
28	Star29	90% Argon / 8% CO2 / 2% Oxygen (Praxair - Stargon® CS)	203.139	1.7918	0.9988
29	P-5	95% Argon / 5% Methane	207.633	1.7307	0.9990
*in micropoise (1 Poise = gram / (cm) (sec))			** Grams/Liter	(NIST REFPROP 7 database)	

Gas Viscosities, Densities and Compressibilities at 0° C

Volumetric Flow Meters Under Pressure

V Series Volumetric Flow Meters are intended for use in low pressure applications. This is because an accurate measurement of the volumetric flow rate by means of differential pressure requires the flow at the differential pressure sensor to be in a laminar state. The state of the flow is quantified by what is known as the Reynolds Number. If the Reynolds Number gets above a certain point, generally accepted as approximately 2000, the flow will become non-laminar. The Reynolds Number for a given Newtonian fluid flow is defined as:

$$Re = \rho VL/\eta$$

Where:

- ρ = density
- V = average velocity
- L = Constant determined by length and geometry of passage
- η = absolute viscosity

From this relationship we see that increasing the gas density or velocity increases the Reynolds Number, and increasing the gas viscosity decreases the Reynolds number. For a given gas in a given meter at a given temperature, L and η are roughly fixed constants.

For the purpose of illustration, let us put two 100 (S)LPM flow meters, identical in every way except that one is a volumetric flow meter and one is a mass flow meter, in series with one another in a pipeline. Now let us pass a small constant air flow through the meters, thus fixing the velocity V through both meters. With the flow fixed, let us begin increasing the pressure, and thus the density ρ . The mass flow meter, which is measuring the absolute pressure and compensating for the density change registers this pressure increase as an increase in mass flow rate because the number of molecules of gas keeps going up in the fixed volume of flow. In addition, the Reynolds number has increased proportionately with the pressure increase because the density goes up with the pressure. If you increase the pressure high enough, the mass flow meter will max out at 100 SLPM, the Reynolds number has increased fairly dramatically, and the volumetric meter still registers your small fixed flow rate.

Now if we maintain the higher pressure and try to take the volumetric meter up to its published full scale flow of 100 LPM, our density ρ AND our velocity V will be high, which often results in a high Reynolds number and non-laminar flow. When the flow is non-laminar, the Poiseuille Equation upon which we base our volumetric flow measurement is no longer valid and the meter reading is therefore no longer valid.

Gas properties also need to be taken into account in deciding whether you can use a volumetric flow meter at a particular line pressure. Helium, which has a relatively low density and a relatively high viscosity at standard conditions, can generally get away with higher pressures in a volumetric flow meter. Propane, on the other hand, has a relatively high density and relatively low viscosity making it a considerably more difficult gas to measure at higher pressures in a volumetric flow meter. In air, most volumetric meters make valid full scale measurements up to 10-15 PSIG line pressure.

TROUBLESHOOTING

Display does not come on or is weak.

Check power and ground connections.

Flow reading is approximately fixed either near zero or near full scale regardless of actual line flow.

Differential pressure sensor may be damaged. Avoid installations that can subject sensor to pressure drops in excess of 10 PSID. A common cause of this problem is instantaneous application of high-pressure gas as from a snap acting solenoid valve upstream of the meter. Damage due to excessive pressure differential is not covered by warranty.

Displayed mass flow, volumetric flow, pressure or temperature is flashing and message MOV, VOV, POV or TOV is displayed:

Our flow meters and controllers display an error message (MOV = mass overrange, VOV = volumetric overrange, POV = pressure overrange, TOV = temperature overrange) when a measured parameter exceeds the range of the sensors in the device. When any item flashes on the display, neither the flashing parameter nor the mass flow measurement is accurate. Reducing the value of the flashing parameter to within specified limits will return the unit to normal operation and accuracy.

Meter reads negative flow when there is a confirmed no flow condition.

This is an indication of an improper tare. If the meter is tared while there is flow, that flow is accepted as zero flow. When an actual zero flow condition exists, the meter will read a negative flow. Simply re-tare at the confirmed zero flow condition. Also note that while the meter is intended for positive flow, it will read negative flow with reasonable accuracy (it is not calibrated for bi-directional flow) and no damage will result.

Meter does not agree with another meter I have in line.

Volumetric meters will often not agree with one another when put in series because they are affected by pressure drops. Volumetric flow meters should not be compared to mass flow meters. Mass flow meters can be compared against one another provided there are no leaks between the two meters and they are set to the same standard temperature and pressure. Both meters must also be calibrated (or set) for the gas being measured. M Series mass flow meters are normally set to Standard Temperature and Pressure conditions of 25° C and 14.696 PSIA. Note: it is possible to special order meters with a customer specified set of standard conditions. The calibration sheet provided with each meter lists its standard conditions.

Flow flutters or is jumpy.

The meters are very fast and will pick up any actual flow fluctuations such as from a diaphragm pump, etc. Also, inspect the inside of the upstream connection for debris such as a Teflon tape shreds. Note: M & V Series meters feature a programmable geometric running average (GRA) that can aid in allowing a rapidly fluctuating flow to be read (see "Pressure Averaging" and "Flow Averaging" page 15).

The output signal is lower than the reading at the display.

This can occur if the output signal is measured some distance from the meter as voltage drops in the wires increase with distance. Using heavier gauge wires, especially in the ground wire, can reduce this effect.

My volumetric meter reading is strange, inconsistent, or incorrect.

Make sure you use a volumetric flow meter only under low pressure (close to atmospheric) and with little to no back pressure for accurate readings. Mass meters should be used for higher pressure applications. See page 28.

RS-232 Serial Communications is not responding.

Check that your meter is powered and connected properly. Be sure that the port on the computer to which the meter is connected is active. Confirm that the port settings are correct per the RS-232 instructions in this manual (Check the RS-232 communications select screen for current meter readings). Close HyperTerminal® and reopen it. Reboot your PC.

Slower response than specified.

M and V Series meters feature a programmable Geometric Running Average (GRA). Depending on the full scale range of the meter, it may have the GRA set to enhance the stability/readability of the display, which would result in slower perceived response time. Please see “Pressure Averaging” and “Flow Averaging” on page 15.

Jumps to zero at low flow.

M and V Series meters feature a programmable zero deadband. The factory setting is usually 0.5% of full scale. This can be adjusted between NONE and 3.2% of full scale. See “Display Zero Deadband” on page 15.

Discrepancies between old and new units.

Please see “Standard Gas Data Tables” explanation on page 25.

Maintenance and Recalibration

General: M and V Series Flow Meters require minimal maintenance. They have no moving parts. The single most important thing that affects the life and accuracy of these devices is the quality of the gas being measured. The meter is designed to measure CLEAN, DRY, NON-CORROSIVE gases. A 20 micron filter (50 micron for 50 LPM and up) mounted upstream of the meter is highly recommended. Moisture, oil, and other contaminants can affect the laminar flow elements and/or reduce the area that is used to calculate the flow rate. This directly affects the accuracy.

Recalibration: The recommended period for recalibration is once every year. Providing that the CLEAN, DRY, and NON-CORROSIVE mantra is observed, this periodic recalibration is sufficient. A label located on the back of the meter lists the recalibration due date. The meter should be returned to the factory for recalibration near the listed due date. Before calling to schedule a recalibration, please note the serial number on the back of the meter. The Serial Number, Model Number, and Date of Manufacture are also available on the Manufacture Data 2 screen (page 14).

Cleaning: M and V Series Flow Meters require no periodic cleaning. If necessary, the outside of the meter can be cleaned with a soft dry rag. Avoid excess moisture or solvents.

For repairs, recalibrations, or recycling of this product, contact:

Alicat Scientific, Inc.
2045 N Forbes Blvd. Bldg.103
Tucson, Arizona 85745
USA
Ph. 520-290-6060
Fax 520-290-0109
email: info@alicatescientific.com
Web site: www.alicatescientific.com

Technical Data for Micro-Flow and Ultra-Low Flow Mass & Volumetric Flow Meters 0 to 0.5SCCM Full Scale through 0 to 50SCCM Full Scale

The following specifications are for the standard configuration of the Alicat product as shipped from the factory. There are many low-cost customization options available.

Specification	Mass Meter	Volumetric Meter	Description
Accuracy	± (0.8% of Reading + 0.2% of Full Scale)		At calibration conditions after tare
High Accuracy Option	± (0.4% of Reading + 0.2% of Full Scale)		At calibration conditions after tare
Repeatability	± 0.2%		Full Scale
Operating Range	1% to 100% Full Scale		Measure
Typical Response Time	10		Milliseconds (Adjustable)
Standard Conditions (STP)	25°C & 14.696PSIA	Not Applicable	Mass Reference Conditions
Operating Temperature	-10 to +50		°Celsius
Zero Shift	0.02%		Full Scale / °Celsius / Atm
Span Shift	0.02%		Full Scale / °Celsius / Atm
Humidity Range	0 to 100%		Non-Condensing
Measurable Flow Rate	128%		Full Scale
Maximum Pressure	145	145 ¹	PSIG
Output Signal Digital	Mass, Volume, Pressure & Temperature	Volumetric Flow	RS-232 Serial
Output Signal Analog	Mass Flow	Volumetric Flow	0-5Vdc
Optional Output Signal Secondary Analog	Mass, Volumetric Pressure or Temperature	Volumetric Flow	0-5 Vdc or 0-10Vdc or 4-20mA
Electrical Connections	8 Pin		Mini-DIN
Supply Voltage	7 to 30 Vdc (15-30Vdc for 4-20mA outputs)		
Supply Current	0.035Amp (+ output current on 4-20mA)		
Mounting Attitude Sensitivity	0%		Tare after installation
Warm-up Time	< 1		Second
Wetted Materials ²	303 & 302 Stainless Steel, Viton®, Silicone RTV (Rubber), Glass Reinforced Nylon, Aluminum.		

1. **Volumetric meters only:** Operating pressure limitations determined by Reynolds number thresholds. For operating pressures >10PSIG, please contact Application Assistance for more details.
2. If your application demands a different material, please contact Application Assistance for available options.

Mechanical Specifications

Full Scale Flow Mass Meter	Full Scale Flow Volumetric Meter	Mechanical Dimensions	Process Connections ¹	Pressure Drop ² (PSID)
0.5SCCM to 1SCCM	0.5CCM to 1CCM	3.9"H x 2.4"W x 1.1"D	M5 (10-32) Female Thread*	1.0
2SCCM to 50SCCM	2CCM to 50CCM			1.0

*Units ≤50SCCM F.S. are shipped with M5 (10-32) Male Buna-N O-ring face seal to 1/8" Female NPT fittings. These adaptor fittings were selected for customer convenience in process connection. It should be noted that the 1/8" Female NPT introduces additional dead volume. To minimize dead volume, please see [Accessories](#) for the M5 Male to 1/8"OD compression fitting.

1. Compatible with Beswick®, Swagelok® tube, Parker®, face seal, push connect and compression adapter fittings.
2. Venting to atmosphere. Lower Pressure Drops Available, please contact Application Assistance.

Dimensional Drawings: page 35

Technical Data for Low Flow Mass & Volumetric Flow Meters

0 to 100 SCCM Full Scale through 0 to 20 SLPM Full Scale

The following specifications are for the standard configuration of the Alicat product as shipped from the factory. There are many low-cost customization options available.

Specification	Mass Meter	Volumetric Meter	Description
Accuracy	± (0.8% of Reading + 0.2% of Full Scale)		At calibration conditions after tare
High Accuracy Option	± (0.4% of Reading + 0.2% of Full Scale)		At calibration conditions after tare
Repeatability	± 0.2%		Full Scale
Operating Range	1% to 100% Full Scale		Measure
Typical Response Time	10		Milliseconds (Adjustable)
Standard Conditions (STP)	25°C & 14.696PSIA	Not Applicable	Mass Reference Conditions
Operating Temperature	-10 to +50		°Celsius
Zero Shift	0.02%		Full Scale / °Celsius / Atm
Span Shift	0.02%		Full Scale / °Celsius / Atm
Humidity Range	0 to 100%		Non-Condensing
Measurable Flow Rate	128%		Full Scale
Maximum Pressure	145	145 ¹	PSIG
Output Signal Digital	Mass, Volume, Pressure & Temperature	Volumetric Flow	RS-232 Serial
Output Signal Analog	Mass Flow	Volumetric Flow	0-5Vdc
Optional Output Signal Secondary Analog	Mass, Volumetric Pressure or Temperature	Volumetric Flow	0-5 Vdc or 0-10Vdc or 4-20mA
Electrical Connections	8 Pin		Mini-DIN
Supply Voltage	7 to 30 Vdc (15-30Vdc for 4-20mA outputs)		
Supply Current	0.035Amp (+ output current on 4-20mA)		
Mounting Attitude Sensitivity	0%		Tare after installation
Warm-up Time	< 1		Second
Wetted Materials ²	303 & 302 Stainless Steel, Viton®, Silicone RTV (Rubber), Glass Reinforced Nylon, Aluminum.		
<p>1. Volumetric meters only: Operating pressure limitations determined by Reynolds number thresholds. For operating pressures >10PSIG, please contact Application Assistance for more details.</p> <p>2. If your application demands a different material, please contact Application Assistance for available options.</p>			

Mechanical Specifications

Full Scale Flow Mass Meter	Full Scale Flow Volumetric Meter	Mechanical Dimensions	Process Connections ¹	Pressure Drop ² (PSID)
100SCCM to 10SLPM	100CCM to 10LPM	4.1"H x 2.4"W x 1.1"D	1/8" NPT Female	1.0
20SLPM	20LPM	4.2"H x 2.4"W x 1.1"D	1/8" NPT Female	1.0
<p>1. Compatible with Beswick®, Swagelok® tube, Parker®, face seal, push connect and compression adapter fittings.</p> <p>2. Venting to atmosphere. Lower Pressure Drops Available, please contact Application Assistance.</p>				

Dimensional Drawings: page 35, 36

Technical Data for Moderate Flow Mass & Volumetric Flow Meters

0 to 50 SLPM Full Scale through 0 to 250 SLPM Full Scale

The following specifications are for the standard configuration of the Alicat product as shipped from the factory. There are many low-cost customization options available.

Specification	Mass Meter	Volumetric Meter	Description
Accuracy	± (0.8% of Reading + 0.2% of Full Scale)		At calibration conditions after tare
High Accuracy Option	± (0.4% of Reading + 0.2% of Full Scale)		At calibration conditions after tare
Repeatability	± 0.2%		Full Scale
Operating Range	1% to 100% Full Scale		Measure
Typical Response Time	10		Milliseconds (Adjustable)
Standard Conditions (STP)	25°C & 14.696PSIA	Not Applicable	Mass Reference Conditions
Operating Temperature	-10 to +50		°Celsius
Zero Shift	0.02%		Full Scale / °Celsius / Atm
Span Shift	0.02%		Full Scale / °Celsius / Atm
Humidity Range	0 to 100%		Non-Condensing
Measurable Flow Rate	128%		Full Scale
Maximum Pressure	145	145 ¹	PSIG
Output Signal Digital	Mass, Volume, Pressure & Temperature	Volumetric Flow	RS-232 Serial
Output Signal Analog	Mass Flow	Volumetric Flow	0-5Vdc
Optional Output Signal Secondary Analog	Mass, Volumetric Pressure or Temperature	Volumetric Flow	0-5 Vdc or 0-10Vdc or 4-20mA
Electrical Connections	8 Pin		Mini-DIN
Supply Voltage	7 to 30 Vdc (15-30Vdc for 4-20mA outputs)		
Supply Current	0.035Amp (+ output current on 4-20mA)		
Mounting Attitude Sensitivity	0%		Tare after installation
Warm-up Time	< 1		Second
Wetted Materials ²	303 & 302 Stainless Steel, Viton®, Silicone RTV (Rubber), Glass Reinforced Nylon, Aluminum.		
<p>1. Volumetric meters only: Operating pressure limitations determined by Reynolds number thresholds. For operating pressures >10PSIG, please contact Application Assistance for more details.</p> <p>2. If your application demands a different material, please contact Application Assistance for available options.</p>			

Mechanical Specifications

Full Scale Flow Mass Meter	Full Scale Flow Volumetric Meter	Mechanical Dimensions	Process Connections ¹	Pressure Drop ² (PSID)
50SLPM	50LPM	4.4"H x 4.0"W x 1.1"D	1/4" NPT Female	2.0
100SLPM	100LPM			2.5
250SLPM	250LPM	5.0"H x 4.0"W x 1.6"D	1/2" NPT Female	4.0
<p>1. Compatible with Beswick®, Swagelok® tube, Parker®, face seal, push connect and compression adapter fittings.</p> <p>2. Venting to atmosphere. Lower Pressure Drops Available, please contact Application Assistance.</p>				

Dimensional Drawings: page 36, 37

Technical Data for High Flow Mass & Volumetric Flow Meters

0 to 500 SLPM Full Scale through 0 to 1500 SLPM Full Scale

The following specifications are for the standard configuration of the Alicat product as shipped from the factory. There are many low-cost customization options available.

Specification	Mass Meter	Volumetric Meter	Description
Accuracy	± (0.8% of Reading + 0.2% of Full Scale)		At calibration conditions after tare
High Accuracy Option	± (0.4% of Reading + 0.2% of Full Scale)		At calibration conditions after tare
Repeatability	± 0.2%		Full Scale
Operating Range	1% to 100% Full Scale		Measure
Typical Response Time	10		Milliseconds (Adjustable)
Standard Conditions (STP)	25°C & 14.696PSIA	Not Applicable	Mass Reference Conditions
Operating Temperature	-10 to +50		°Celsius
Zero Shift	0.02%		Full Scale / °Celsius / Atm
Span Shift	0.02%		Full Scale / °Celsius / Atm
Humidity Range	0 to 100%		Non-Condensing
Measurable Flow Rate	128%		Full Scale
Maximum Pressure	145	145 ¹	PSIG
Output Signal Digital	Mass, Volume, Pressure & Temperature	Volumetric Flow	RS-232 Serial
Output Signal Analog	Mass Flow	Volumetric Flow	0-5Vdc
Optional Output Signal Secondary Analog	Mass, Volumetric Pressure or Temperature	Volumetric Flow	0-5 Vdc or 0-10Vdc or 4-20mA
Electrical Connections	8 Pin		Mini-DIN
Supply Voltage	7 to 30 Vdc (15-30Vdc for 4-20mA outputs)		
Supply Current	0.035Amp (+ output current on 4-20mA)		
Mounting Attitude Sensitivity	0%		Tare after installation
Warm-up Time	< 1		Second
Wetted Materials ²	303 & 302 Stainless Steel, Viton®, Silicone RTV (Rubber), Glass Reinforced Nylon, Aluminum.		
<p>1. Volumetric meters only: Operating pressure limitations determined by Reynolds number thresholds. For operating pressures >10PSIG, please contact Application Assistance for more details.</p> <p>2. If your application demands a different material, please contact Application Assistance for available options.</p>			

Mechanical Specifications

Full Scale Flow Mass Meter	Full Scale Flow Volumetric Meter	Mechanical Dimensions	Process Connections ¹	Pressure Drop ² (PSID)
500SLPM	500LPM	5.0"H x 4.0"W x 1.6"D	3/4" NPT Female	4.0
1000SLPM	1000LPM			6.0
1500SLPM	1500LPM			9.0
<p>1. Compatible with Beswick®, Swagelok® tube, Parker®, face seal, push connect and compression adapter fittings.</p> <p>2. Venting to atmosphere. Lower Pressure Drops Available, please contact Application Assistance.</p>				

Dimensional Drawings: page 37

M & V Series:

- 0 – 0.5SCCM
- 0 – 1SCCM
- 0 – 2SCCM
- 0 – 5SCCM
- 0 – 10SCCM
- 0 – 20SCCM
- 0 – 50SCCM

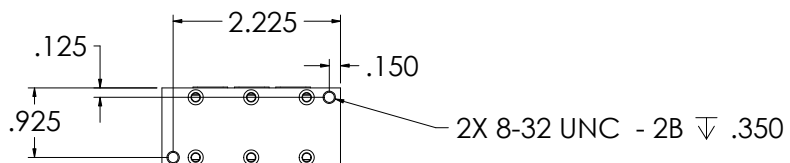
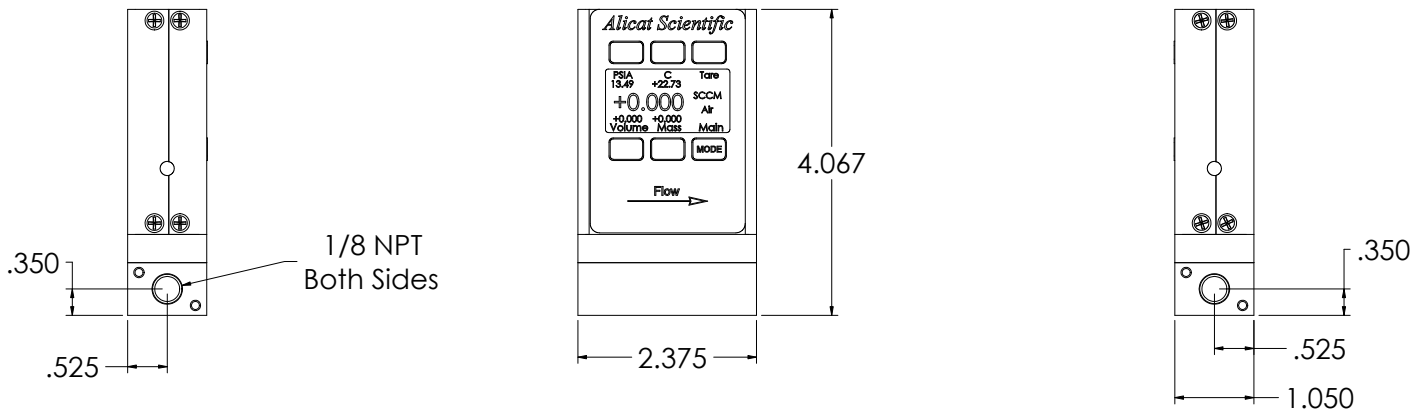
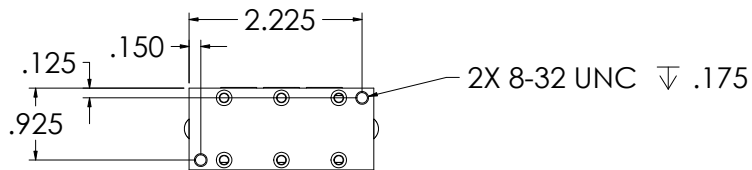
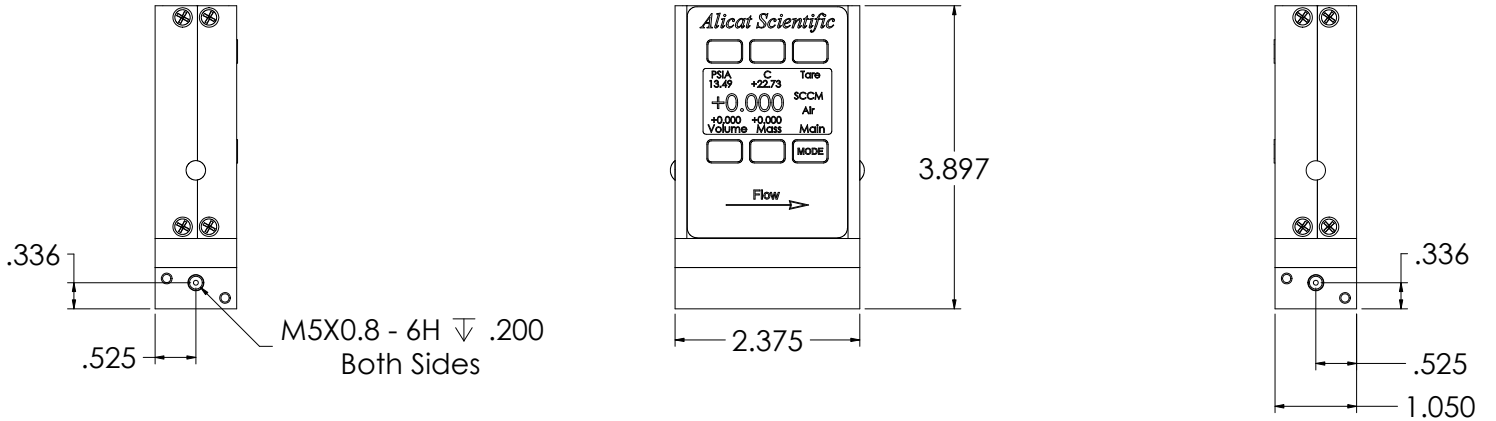
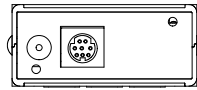

M & V Series:

- 0 – 100SCCM
- 0 – 200SCCM
- 0 – 500SCCM
- 0 – 1SLPM
- 0 – 2SLPM
- 0 – 5SLPM
- 0 – 10SLPM

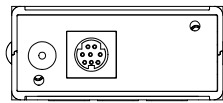

M & V Series:
0 – 20SLPM

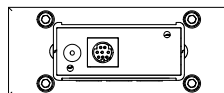
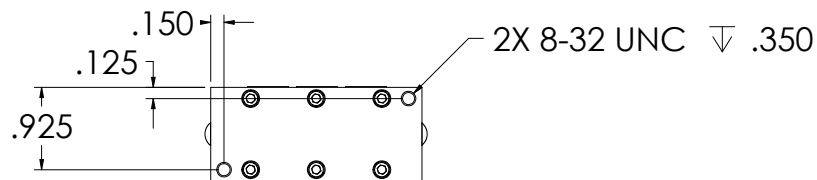
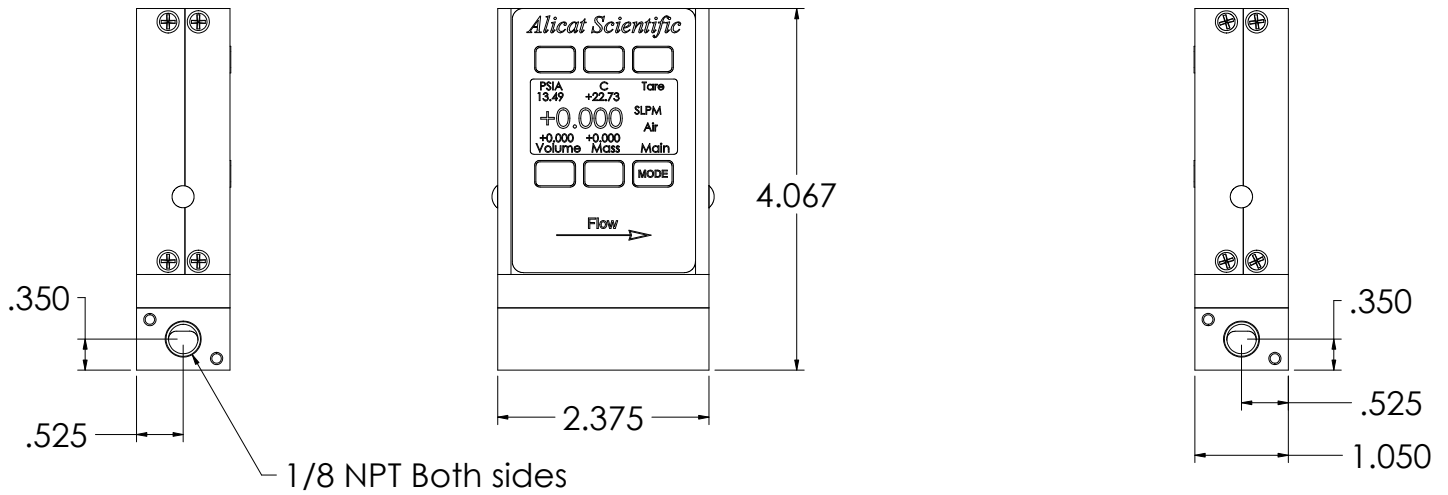

M & V Series:
0 – 50SLPM
0 – 100SLPM

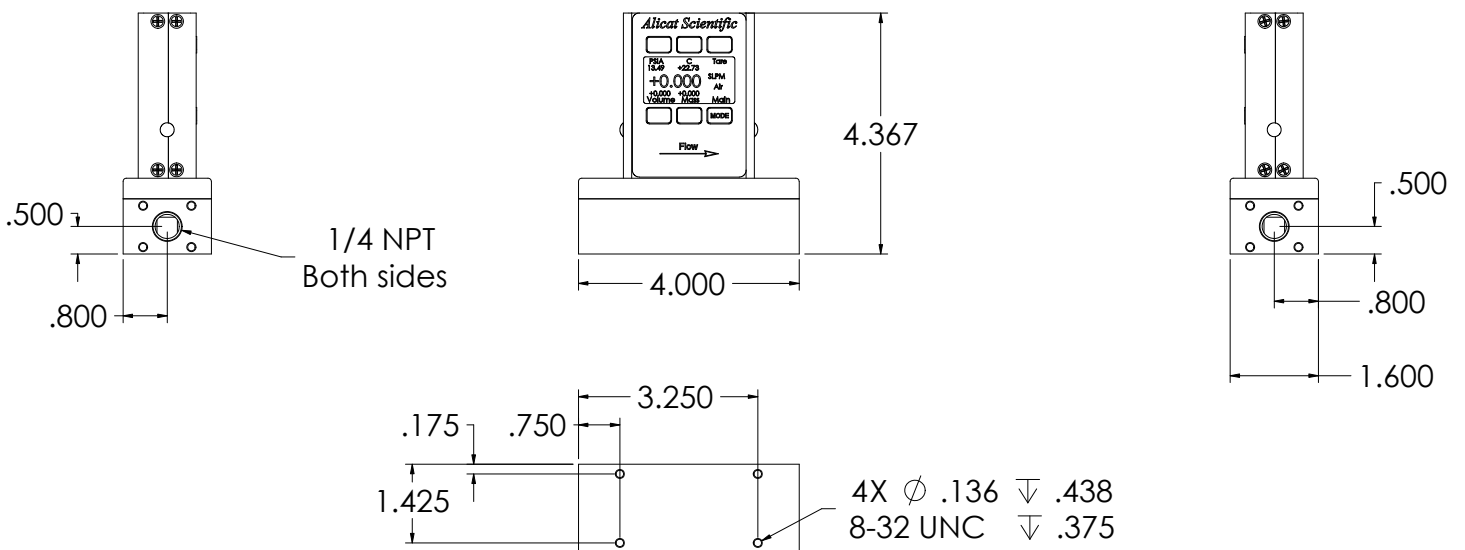

M & V Series:
0 – 250SLPM

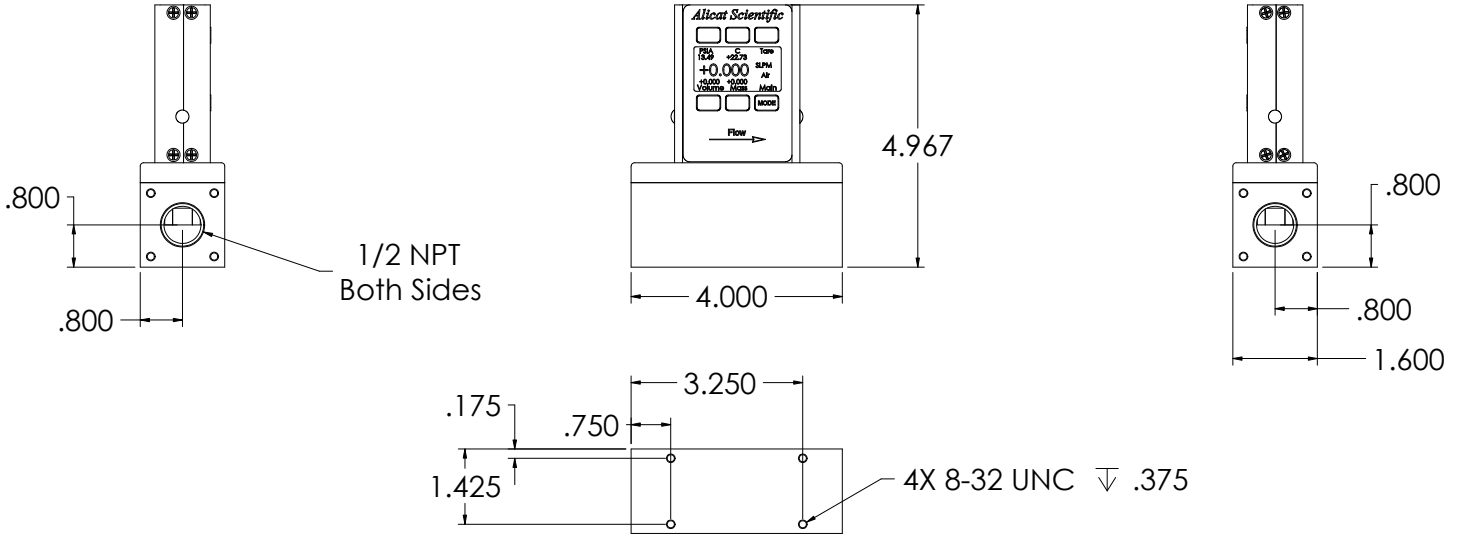
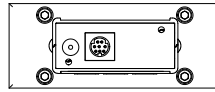

M & V Series:
0 – 500SLPM
0 – 1000SLPM
0 – 1500SLPM

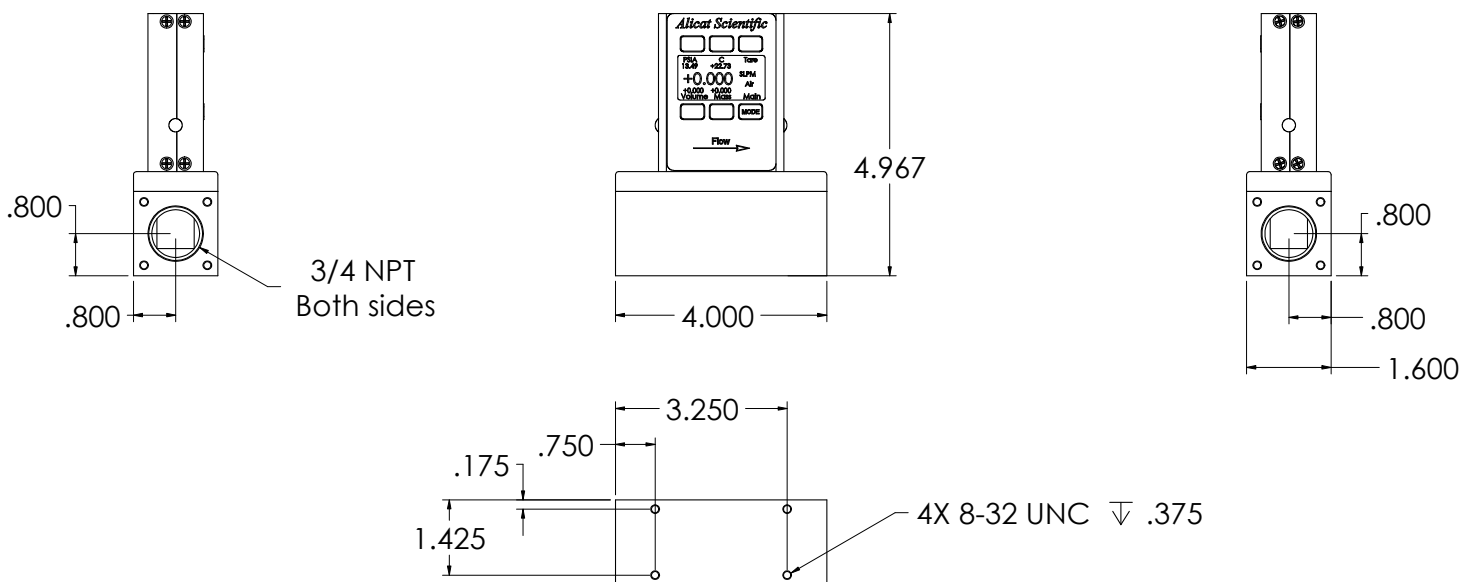
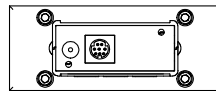

Option: Totalizing Mode Screen

M and V Series Flow Meters and Controllers can be purchased with the Totalizing Mode option. This option adds an additional mode screen that displays the total flow (normally in the units of the main flow screen) that has passed through the meter or controller since the last time the totalizer was cleared. The Totalizing Mode screen shown below is accessed by pushing the “MODE” button until the label over it reads “Total”. *If your meter is ordered with Totalizing Mode option, pushing the “Mode” button once will bring up the “Totalizing Mode” display. Pushing “Mode” a second time will bring up the “Select Menu” display. Pushing it a third time will return you to the Main Mode Sreen.*

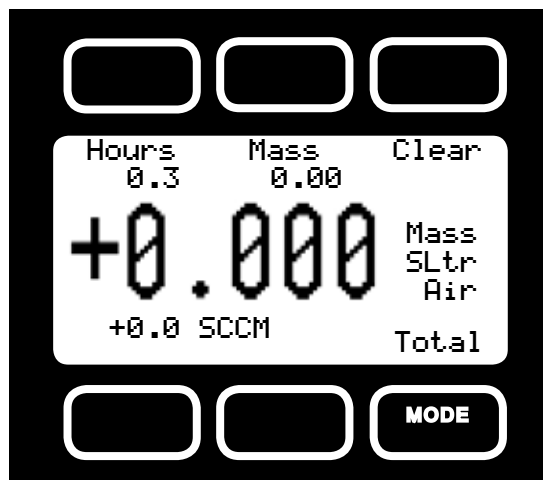

Counter – The counter can have as many as six digits. At the time of order, the customer must specify the resolution of the count. This directly affects the maximum count. For instance, if a resolution of 1/100ths of a liter is specified on a meter which is totalizing in liters, the maximum count would be 9999.99 liters. If the same unit were specified with a 1 liter resolution, the maximum count would be 999999 liters.

Rollover – The customer can also specify at the time of order what the totalizer is to do when the maximum count is reached. The following options may be specified:

No Rollover – When the counter reaches the maximum count it stops counting until the counter is cleared.

Rollover – When the counter reaches the maximum count it automatically rolls over to zero and continues counting until the counter is cleared.

Rollover with Notification – When the counter reaches the maximum count it automatically rolls over to zero, displays an overflow error, and continues counting until the counter is cleared.

Hours – The display will show elapsed time since the last reset in 0.1 hour increments. The maximum measurable elapsed time is 6553.5 hours (about nine months). The hours count resets when the “clear” button is pushed, an RS-232 clear is executed or on loss of power

Clear – The counter can be reset to zero at any time by pushing the dynamically labeled “Clear” button located above the upper right side of the display. To clear the counter via RS-232, establish serial communication with the meter or controller as described in the RS-232 section of the manual. To reset the counter, enter the following commands:

In Streaming Mode: `$$T <Enter>`

In Polling (addressable) Mode: `Address$$T <Enter>` (e.g. `B$$T <Enter>`)

Option: 9 Volt Battery Pack

A Battery Pack that uses a common 9 Volt battery can be mounted to the top of your 16 Series Flow Meter or Pressure Gauge. Power is passed from the battery to the flow meter through the 8 pin Mini-DIN connector. Output signals from the flow meter or pressure gauge are passed through the male connector on the bottom of the battery pack to the female connector on top of the battery pack so the signals can be accessed normally. Turn the switch on top of the battery pack off when the meter is not in use. (**Note: The Battery Pack cannot be used with Flow or Pressure Controllers**)

Normal (9V alkaline) battery life is approximately 8 hours (30-40 hours with a 9V-lithium battery), however many factors can affect this. Replace the battery as often as required. A common indicator that the battery may be approaching the end of its life is a sharp increase in the temperature indicated on the meter. This false signal can result when the voltage drops below its normally regulated level. This can affect the accuracy of the meter so it is good practice to check that the temperature is approximately correct (25°C is about room temperature) or use a fresh battery, especially if the measurement is critical.

Replacing the Battery:

The battery can be replaced with the battery pack installed on the flow meter.

1. Remove the four Phillips head screws from the back cover and gently remove it as shown below.
2. Remove the 9V battery, pulling the top of the battery out first.
3. Remove the old battery from the harness and replace it with a new battery.
4. Install the new battery bottom end first and replace the back cover so that the cushioning pad presses directly down on the battery.
5. Replace the four Phillips head screws.

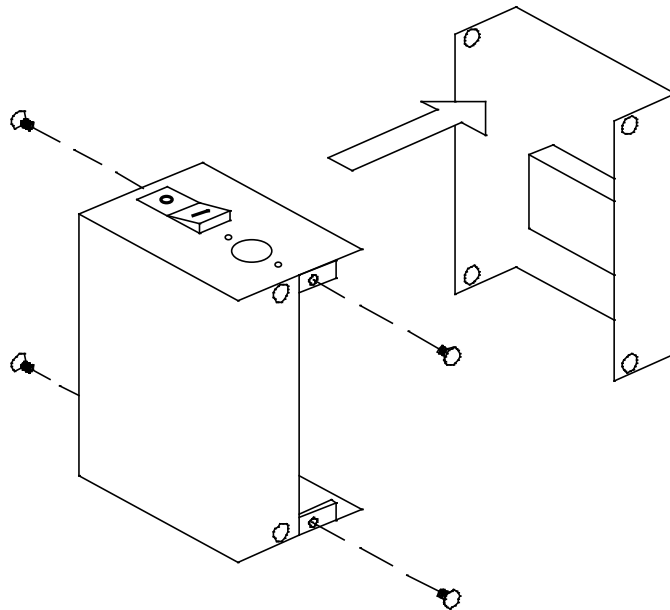

Battery Pack Back Cover Removal

Battery Pack Installation and Removal:

The battery must be removed before the battery pack can be installed or removed.

1. Remove the back cover of the battery pack and remove the battery if installed (see “Replacing the Battery”).
2. Carefully place the battery pack on top of the flow meter, being especially careful that the pins in the 8 pin Mini-DIN plug are inserted properly into the 8 pin Mini-DIN socket on top of the flow meter. The two screws trapped in the bottom of the battery pack will not allow the plug to be completely inserted into the socket until they are screwed into place.
3. Slip the included hex wrench into either of the two holes on the top of the battery pack as shown below and start the screw into the corresponding threaded hole in the top of the meter.
4. Before the screw is tightened down all the way, move the hex wrench to the other hole and tighten the other screw gently down. Avoid over tightening the screw.
5. Return the hex wrench to the first hole and tighten the first screw gently down. Avoid over tightening the screw.
6. Install the battery and replace the back cover as described above.
7. Removal is the reverse of the installation.

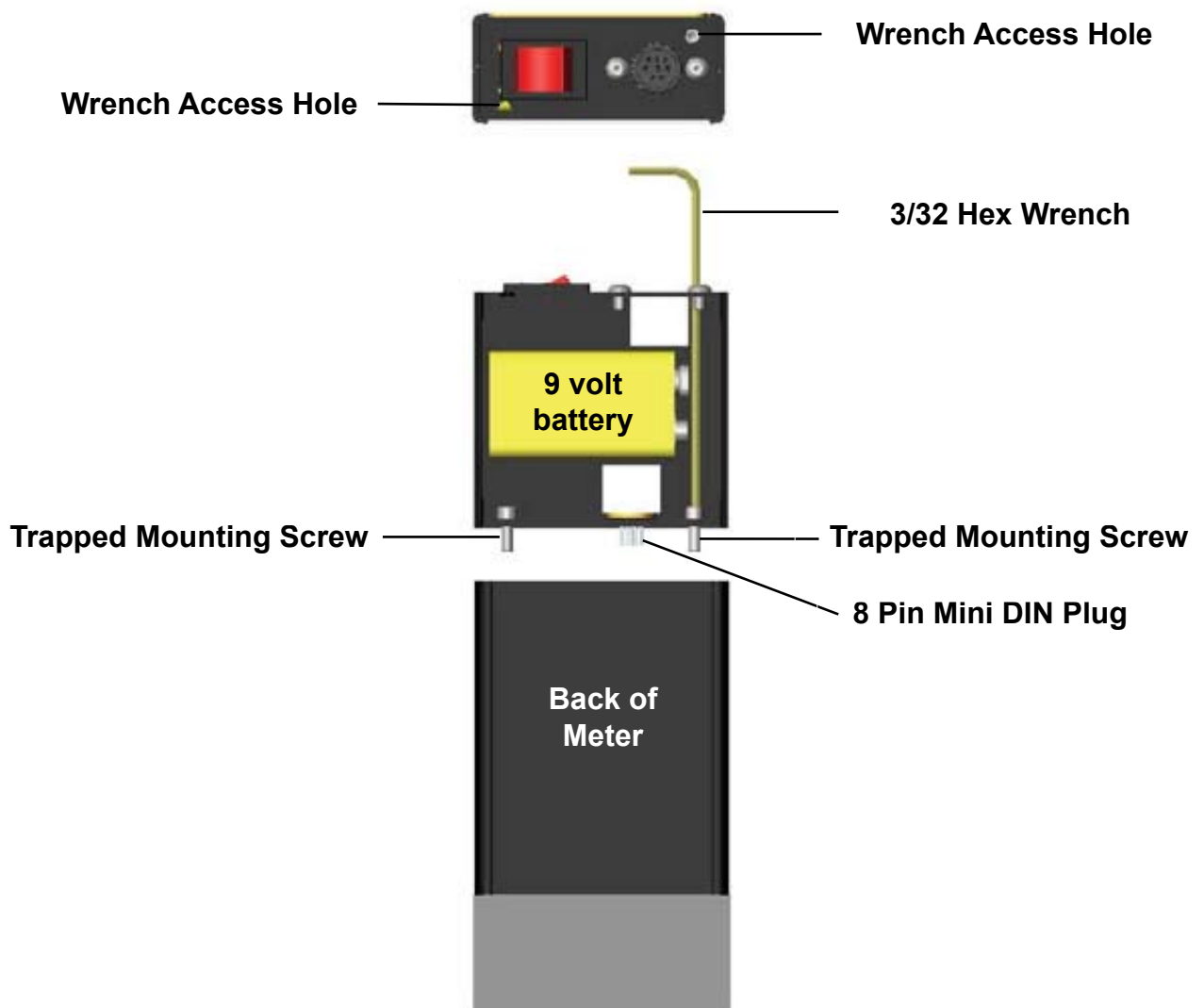

Battery Pack Installation/Removal

Option: Local Set-Point Module

The Local Set-Point Module (**LSPM**) is designed to provide the user with a simple “turn of the dial” method of changing a flow or pressure controller set-point.

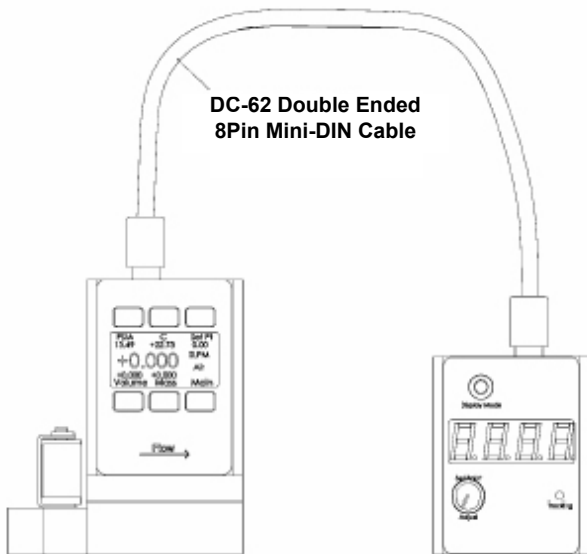

The LSPM features a set-point control dial, a digital LED display which can be set to show either the set-point or the actual process measurement, and a tracking alarm LED which glows red whenever the actual process measurement deviates from the set-point by more than 2% of full scale. This device is handy as a remote control/display device where the controller is out of convenient reach or view. It is supplied with a 6' double ended cable to run between the controller and the LSPM. There is an additional 8 pin Mini-DIN port on the LSPM that allows access to normal signal/power functions of the controller's Mini-DIN port.

- 8 Pin Mini-DIN connector connects to controller or to external device for power or output signal recording
- LCD Display can display either the set-point or the process measurement.
- Set-point Adjustment Knob provides simple “dial it in” process changes.
- Display button switches display between actual set-point and measured flow parameter.
- LED indicator switches from green to red when the measured parameter deviates from the set-point by more than 2% of full scale.

Operation Notes: The LSPM requires a double ended DC-62 8 Pin Mini-DIN cable connected between either the top or bottom connector socket of the LSPM to the connector socket on top of the controller. The two connector sockets on the LSPM are “pass through” connected so that the unused socket can be connected to a DC-61 single ended cable for connection of output signals and/or power. Appropriate power can be connected to either the LSPM or the controller, whichever is more convenient. Unless specially ordered otherwise, the LSPM utilizes the 5.12 Vdc output pin on the controller (pin 2) as a source. The 5.12 volts is connected through the potentiometer and returned to the controller on the set-point pin (pin 4) as a 0 though 5.12 Vdc input signal depending on the position of the adjustment knob.

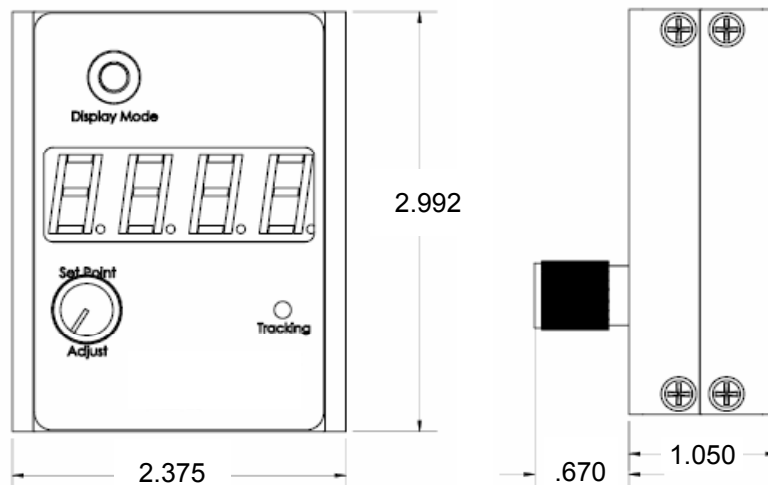

Option: Remote Electronics for High Line or Gas Temperatures

Some applications involve operating temperatures outside the standard Alicat device specifications. A solution using remote electronics is available. (This option is not applicable to liquid devices.)

The flow body's components are minimized to only the required sensors. The flow data is sent to the microprocessor electronics up to 6 feet away from the sensor package. Relocating the sensitive electronics, including the LCD, allows for installation of the flow body in ambient temperatures as high as 85° Celsius with gas temperatures under 100° Celsius.

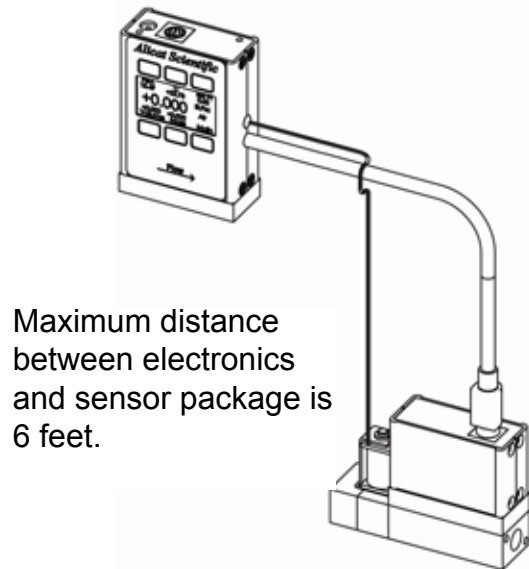

In these applications we recommend our custom gauge calibration at a gas temperature of up to 70° Celsius. This will reduce zero shift errors that occur when actual gas flow temperatures deviate substantially from the gas calibration temperature. This configuration is also used in integrations that require a compact flow package at the installation point.

Accessory: BB-9 Multi-Drop Box



The **BB-9 Multi-Drop Box** makes it convenient to wire multiple flow and/or pressure devices to a single RS-232 port.

The Multi-Drop Box has nine 8 pin mini-DIN ports available. The ports are to be used with a standard double ended 8 pin mini-DIN (DC-62) style cable going from the box to each flow or pressure device. A single DB9 D-SUB type connector (COM PORT) connects, using the included cable, to the serial connector on a PC or laptop.

All of the flow and/or pressure devices are powered via a terminal block on the front of the box.

If more than nine devices will be required, additional Multi-Drop Boxes can be daisy chained together with a double ended 8 pin mini-DIN cable plugged into any receptacle on both boxes.

Accessory: RS-232 to RS-485 Converter

Since most computers have RS-232 communication onboard, Alicat has chosen RS-232 as the digital standard on all of its flow instruments. For those using RS-485 as their primary standard, our **RS-232 to RS-485** converter will allow interface between an RS-485 system and Alicat's flow instrumentation.

Accessory: Flow Vision™ Software

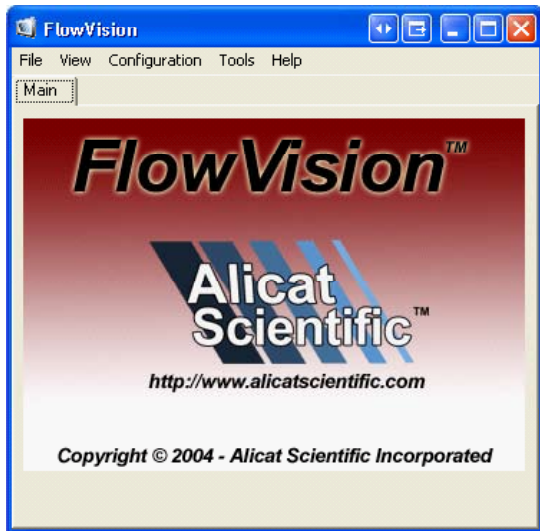

Flow Vision™ is an intuitive software interface to help your experimental test cycles run smoother and make your integration engineering time shorter! This easy to use software features a simple graphical user interface, multiple device management capabilities and straightforward script building for controller command sequences.

Automatic Configuration: Automatically finds and configures Alicat devices connected to your computer.

Session Saving: Your current configuration data can be saved and reloaded for ease of experiment repetition.

Data Capturing & Logging: Captures data from your flow or pressure units and logs it in a Microsoft® Excel® file or plain text file – making it easy to graph and track your test data.

Script Building: Allows you to create scripts that change or sample your flow or pressure unit's setting at timed intervals.

Flow Vision™ supports all RS-232 Serial Communications, including quick selection of the calibration for individual **gas selectability** and our popular end user access to the terms of the **PID loop tuning**



Flow Vision™ mimics Alicat's Standard Dynamic Displays on your PC. Use your mouse to execute all membrane switch functions and more!



Flow Vision™ supports multiple devices connected to the same RS-232 port. Simply connect each device to a BB-9 Multi-Drop Box, then using the device addressability, assign an identifier to each unit. Now you can easily control and monitor varying flow rates for gas mixing, gas analysis, combined testing of multiple parts and other applications.

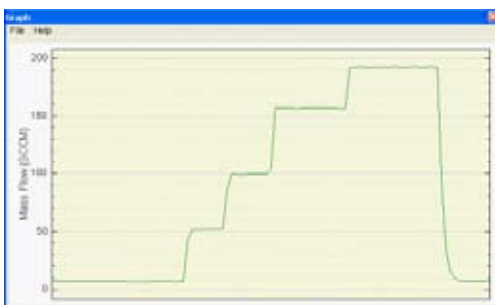
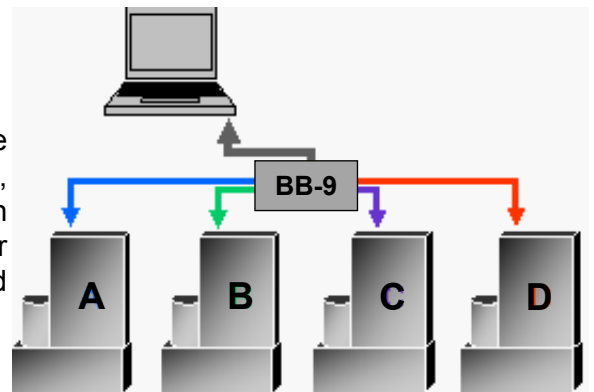

Flow Vision™'s Graphing Utility continuously displays the data points of the main parameter selected. The graph auto scales the Y-axis for the range of the selected parameter. Includes easy pause, run, stop and print features.

Flow Vision™ System Requirements:

Microsoft® Windows® 2000 or Windows® XP ♦ 2MB hard disk space
Available serial port (Some laptop computers are not equipped with serial ports. A virtual serial port can be created using a USB to Serial adapter)

Accessories

Part Number	Description
FVISION	Flow Vision™ software for interface with all Alicat instruments
BB-9	Multi-Drop Box
REMOTE	Remote electronics with display
LSPM	Local Set-Point Module (Controllers Only)
BPACK	9 volt battery pack (Meters and Gauges Only)
PCASE	Industrial carry and storage case for portable meters/gauges
DC-61	8 Pin Male Mini-DIN connector cable, single ended, 6 foot length
DC-62	8 Pin Male Mini-DIN connector cable, double ended, 6 foot length
DC-251	8 Pin Male Mini-DIN connector cable, single ended, 25 foot length
DC-252	8 Pin Male Mini-DIN connector cable, double ended, 25 foot length
DC-6RT	8 Pin Male Right Angle Mini-Din Cable, single ended, 6 foot length
MD8DB9	8 Pin Male Mini-DIN to DB9 Female Adapter, 6 foot length
IC-10	Industrial cable, 6 Pin, single ended, 10 foot length
PVPS	AC to DC 12 Volt Power Supply Adapter
PVPS24	AC to DC 24 Volt Power Supply Adapter
PVPSE	AC to DC 12 Volt European Power Supply Adapter
PVPSE24	AC to DC 24 Volt European Power Supply Adapter
RS485-KIT	RS-232 to RS-485 Converter
RD	Remote Panel Mount Display

	ALICAT DEVICE PROCESS CONNECTION				
	M5 (10-32)	1/8"	1/4"	1/2"	3/4"
COMPRESSION FITTING					
1/8"	SS-200-1-0157	SS-200-1-2	SS-200-1-4	SS-200-1-8	
1/4"	SS-400-1-0256	SS-400-1-2	SS-400-1-4	SS-400-1-8	SS-400-1-12
1/2"		SS-810-1-2	SS-810-1-4	SS-810-1-8	SS-810-1-12
3/4"				SS-1210-1-8	SS-1210-1-12
3mm		SS-3M0-1-2	SS-3M0-1-4		
4mm		SS-4M0-1-2	SS-4M0-1-4		
6mm		SS-6M0-1-2	SS-6M0-1-4	SS-6M0-1-8	
8mm		SS-8M0-1-2	SS-8M0-1-4	SS-8M0-1-8	
12mm		SS-12M0-1-2	SS-12M0-1-4	SS-12M0-1-8	SS-12M0-1-12
16mm				SS-16M0-1-8	SS-16M0-1-12
FILTER					
10 micron		2F-F2L-10-B			
20 micron	CF-303-20-316				
50 micron		2F-F2L-50-B	4F-F4L-50-B	8F-F8L-50-B	12F-F12L-50-B
Adapter	410133	Male M5 (10-32) Buna-N O-ring face seal to 1/8" Female NPT			